

LNT Programmer's Manual using XML

Pathfinder® 6057 Printer
Pathfinder® 6059 Printer
Pathfinder® 6140 Printer

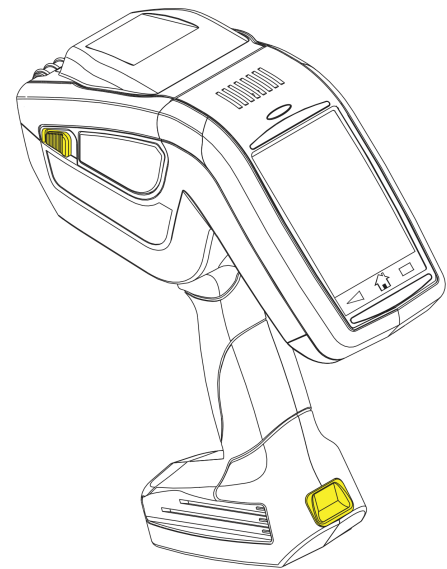

TC6057LNTPM Rev AL
11/20
Classification: Avery Dennison - Public

Each product and program carries a respective written warranty, the only warranty on which the customer can rely. Avery Dennison Corp. reserves the right to make changes in the product, the programs, and their availability at any time and without notice. Although Avery Dennison Corp. has made every effort to provide complete and accurate information in this manual, Avery Dennison Corp. shall not be liable for any omissions or inaccuracies. Any update will be incorporated in a later edition of this manual.

©2011 Avery Dennison Corp. All rights reserved. No part of this publication may be reproduced, transmitted, stored in a retrieval system, or translated into any language in any form by any means, without the prior written permission of Avery Dennison Corp.

Trademarks

Avery Dennison® and Pathfinder® are registered trademarks of Avery Dennison Corporation. Bluetooth® is a registered trademark owned by Bluetooth SIG, Inc.

Avery Dennison
170 Monarch Lane
Miamisburg, OH 45342



TABLE OF CONTENTS

- INTRODUCTION 1-1**
 - About the Printers 1-1
 - Creating a LNT File 1-1
 - Standard Syntax Guidelines 1-2
 - Related Documentation..... 1-2
 - Supported File Types..... 1-3
 - Transferring Files to the 6057 Printer 1-3
 - Using Fonts with the 6057 Printer..... 1-6
 - Using Non-Resident Fonts 1-6
 - Installing Fonts 1-6
 - Error Reporting with the 6057 Printer..... 1-6
 - Enabling the “Field Off Tag” Warning..... 1-7
 - Transferring Files to the 6059 Printer 1-7
 - Using Fonts with the 6059 Printer..... 1-8
 - Error Reporting with the 6059 Printer..... 1-8
 - Transferring Files to the 6140 Printer 1-8
 - Error Reporting with the 6140 Printer..... 1-8
 - LNT Design Tips 1-9
- DEFINING PRINTER SETUP XML TAGS..... 2-1**
 - Defining Printer Setup Tags 2-1
 - Defining the Job Container (Required)..... 2-1
 - Defining the LabelSize Tag (Required) 2-1
 - Defining the Energy Tag (Optional) 2-2
 - Defining the Contrast Tag (Optional) 2-2
 - Defining the PrintSpeed Tag (Optional)..... 2-3
 - Defining the UseBlackMark Tag (Optional) 2-3
 - Defining the UseOnDemand Tag (Optional)..... 2-3
 - Defining the SensorMode Tag (Optional)..... 2-4
 - Defining the Quantity Tag (Optional) 2-4
 - Defining the Image Container (Required) 2-4
 - Defining the ImageSize Tag (Required) 2-4
 - Adjusting the Supply Position 2-7
 - Setting a Negative Supply Position (Using Backfeed on the 6057 Printer)..... 2-7
 - Setting the Supply Position on the 6059 Printer..... 2-7
- DEFINING FIELD SETUP XML TAGS 3-1**
 - Defining the Fields Container (Required)..... 3-1
 - Defining the TextField (Required)..... 3-1
 - Defining the BoundingBox Tag (Required for non-barcode fields) 3-2
 - Defining the Shape Tag (Optional) 3-2
 - Defining the Line Thickness Tag (Optional) 3-2
 - Defining the Data Tag (Required)..... 3-3
 - Defining the Volatile Tag (Required) 3-4

Defining the Rotation Tag (Optional)	3-4
Defining the DrawMode Tag (Optional)	3-5
Defining the Font Tag (Optional)	3-6
Defining the VerticalJustification Tag (Optional).....	3-10
Defining the HorizontalJustification Tag (Optional)	3-10
Defining the BackgroundColor Tag (Optional)	3-11
Defining the ForegroundColor Tag (Optional).....	3-11
Defining the BarcodeField (Required)	3-11
Defining the Data Tag (Required).....	3-12
Defining the Origin Tag (Required).....	3-13
Defining the BarHeight Tag (Required).....	3-14
Defining the Type Tag (Required)	3-14
Defining the Orientation Tag (Optional)	3-14
Defining the Options Tag (Optional)	3-14
Defining the LineField Tag (Required)	3-15
Defining the Offset1 Tag (Required).....	3-15
Defining the Offset2 Tag (Required).....	3-16
Defining the Thickness Tag (Required).....	3-16
Defining the BoxField Tag (Required)	3-17
Defining the Box Tag (Required).....	3-17
Defining the Line Thickness Tag (Required).....	3-18
Defining the DrawMode Tag (Optional)	3-18
Defining the LineColor Tag (Optional)	3-18
Defining the FillColor Tag (Optional)	3-18
Defining an EllipseField (Required)	3-19
Defining the BoundingBox Tag (Required)	3-19
Defining the Line Thickness Tag (Required).....	3-20
Defining the DrawMode Tag (Optional)	3-20
Defining the LineColor Tag (Optional)	3-20
Defining the FillColor Tag (Optional)	3-20
Defining a GraphicField (Required)	3-21
Defining the Volatile Tag (Required)	3-21
Defining the BoundingBox Tag (Required)	3-21
Defining the Data Tag (Required).....	3-22
Defining the DrawMode Tag (Optional).....	3-22
Defining the VerticalJustification Tag (Optional).....	3-22
Defining the HorizontalJustification Tag (Optional).....	3-23
DEFINING BAR CODE OPTIONS	4-1
Scannable Bar Codes vs. Printable Bar Codes.....	4-1
Defining the Codabar Options Tag (Optional)	4-2
Defining the Code 16K Options Tag (Optional)	4-3
Defining the Code 39 Options Tag (Optional).....	4-4
Defining the Code 93 Options Tag (Optional).....	4-5
Defining the Code 128 Options Tag (Optional).....	4-5
Defining the Interleaved 2of5 Options Tag (Optional)	4-6

Defining the MSI Options Tag (Optional)	4-7
Defining the UPCA/UPCE/EAN Options Tag (Optional)	4-7
Defining the Data Matrix Options Tag (Optional)	4-8
Defining the GS1 DataBar Options Tag (Optional).....	4-9
Defining the MaxiCode Options Tag (Optional)	4-10
Defining the Data Tag (Required)	4-11
Defining the Micro PDF417 Options Tag (Optional)	4-13
Defining the PDF417 Options Tag (Optional)	4-14
Defining Data for POSTNET (Optional)	4-15
Defining the Quick Response Options Tag (Optional)	4-15
Using MPCLSTYLE for the Quick Response Bar Code.....	4-17
Defining the Data Tag (Required).....	4-17
CREATING JOB DATA.....	5-1
Defining the JobData Container (Required)	5-1
Defining the Field Container (Optional).....	5-1
Defining Printer Setup XML Tags.....	5-2
Defining the Quantity Tag (Optional)	5-2
Defining the Energy Tag (Optional)	5-2
Defining the Contrast Tag (Optional)	5-2
Defining the PrintSpeed Tag (Optional).....	5-3
Defining the UseBlackMark Tag (Optional)	5-3
Defining the UseOnDemand Tag (Optional)	5-3
Defining the SensorMode Tag (Optional).....	5-4
Sample JobData File	5-4
ERROR MESSAGES	6-1
Hard Printer Errors.....	6-3
SAMPLE LNT FILES	A-1
Code 39 Bar Code with Text Sample	A-1
Fixed Field Sample.....	A-2
Text Field Sample	A-3
International Font Sample	A-4
DESIGN TOOLS	B-1
Origin (Millimeters).....	B-2
Origin (Inches).....	B-3
CODE PAGES	C-1
Supported Code Pages	C-1
Code Page 0 (Internal)	C-1
Code Page 100 (Macintosh)	C-2
Code Page 101 (Wingdings).....	C-2

INTRODUCTION

This manual is for the developer who is creating and designing custom labels for the

- ◆ Pathfinder® 6057 printer
- ◆ Pathfinder® 6059 printer
- ◆ Pathfinder® 6140 printer

You must develop an application that uses the files you create.

Use the Avery Dennison® Label Design Utility (from our website) to create LNT files using a WYSIWYG interface.

About the Printers

The 6057 *Software Development Kit* (SDK) helps developers write applications for the 6057 printer. This printer operates on a Microsoft® Windows-based CE platform.

The 6059 *Software Development Kit* (SDK) helps developers write applications for the 6059 printer. The printer uses the Android™ 7.1 platform.

The 6140 printer is designed to support different operating systems. Each operating system will have its own SDK. For example, the 6140 *iOS* SDK helps developers write applications for their smart device. The 6140 printer with Bluetooth® can be paired/connected with a smart device to scan bar codes and print labels. Refer to the **Sample Application** (Scan and Print) included with the *iOS* SDK for more information.

To print labels/tags on either printer, a LNT (Language Neutral Template) file must be created. This manual describes how to create a LNT file.

Creating a LNT File

The LNT (Language Neutral Template) file defines how your label looks – what type of information appears (text, bar code, line or graphic fields) and where they print on the label.

The LNT file uses XML Version 1.0 programming.

LNT files must contain

- ◆ printer setup XML tags
- ◆ field setup XML tags.

Printer setup tags define the print speed, print contrast, label size, and image size. Field setup tags define the look of the label (including text, bar code, line or box fields).

For example, the label shown on the right contains three field setup tags: one for the text field “PRETZELS,” one for the UPCA bar code field, and one for the price text field “\$.79.”



Standard Syntax Guidelines

Each LNT file must start with the XML declaration:

```
<?xml version="1.0" encoding="UTF-8" ?>
```

To add comments in an LNT file:

```
<!-- start of comment
```

```
--> end of comment
```

```
<!--for Code 39 barcodes -->
```

To comment an entire field:

```
<!--  
<BarcodeField id="Code39BC">  
  <Volatile>1</Volatile>  
  <Origin units="Inches" x="0.800" y="0.170" justification="Center" />  
  <BarHeight units="Inches">0.500000</BarHeight>  
  <Orientation>0</Orientation>  
  <Type>code39</Type>  
  <Options density="12" />  
  <Data max="20" min="0" />  
</BarcodeField>  
-->
```

Related Documentation

The following table describes other documentation for the printer:

Item	Description
<i>Quick Reference</i>	Includes basic start-up information such as supply loading, cleaning and minor troubleshooting.
<i>Operator's Handbook</i> or <i>Equipment Manual</i>	Includes information about using the printer, charging the battery, loading supplies, and more.
<i>System Administrator's Guide</i>	Includes information about printer diagnostics, configuring the scanner, and using scanner diagnostics.

Supported File Types

The printer supports file types with these extensions:

File Extension	Description
bmp gif jpg png	Bitmap Graphics Graphic Interchange Format JPEG/JIFF Image Portable Network Graphic
fon fnt ttf	Font (Microsoft) Font TrueType® Font
job lnt xml	Job File Language Neutral Template Extensible Markup Language Note: The LNT file can also be saved as a .JOB or .XML file. Sample LNT files are included in the \Windows\Resources\LNTs folder on the 6057 Mobile Device (printer).

Transferring Files to the 6057 Printer

This section is not applicable to the 6059 or 6140 printer.

To transfer data files to the 6057 printer, use Microsoft® ActiveSync or Windows® Mobile® Device Center. These instructions are written for Microsoft® ActiveSync:

1. Open the folder with your data files on your computer.
2. Turn on the printer and wait for the desktop to load.
3. Connect the USB cable to your computer and printer.
4. Microsoft® ActiveSync® automatically detects your printer. When prompted to set up a Partnership, select **No**, then click **Next**.
5. Click **Explore** on the ActiveSync utility after it connects to the printer. A new window appears called Mobile Device.
6. Open the destination folder for the data files on the Mobile Device (printer).

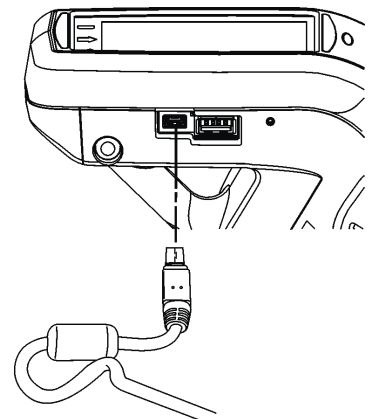

7. Drag the files from your computer to the Mobile Device folder.

To test a LNT file with fixed data, save it to the Mobile Device's (printer's) **Temp\Print** folder.

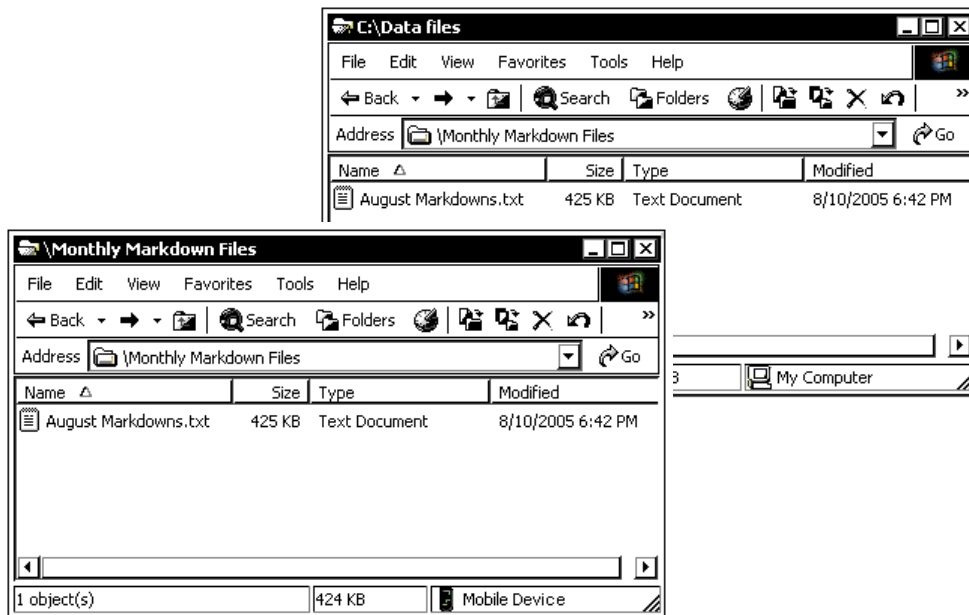

To permanently save any file to the Mobile Device (printer), save it to the **Temp\Install** folder.

Make sure supplies are loaded, you have a fully charged battery, the printer is connected to a host and ready to receive data, and you have an application in the printer. Refer to your *Operator's Handbook* for more information.

These instructions are written for Windows® Mobile® Device Center:

1. Open the folder with your data files on your computer.
2. Turn on the printer and wait for the desktop to load.
3. Connect the USB cable to your computer and printer.
4. Windows® Mobile® Device Center automatically detects your printer. Click **Connect without setting up your device to continue**.
5. Click **File Management**, then click **Browse the contents of your device**.



6. Select your device.
7. Open the destination folder for the data files on the Mobile Device (printer).
8. Drag the files from your computer to the Mobile Device folder.

To test a LNT file with fixed data, save it to the Mobile Device's (printer's) **Temp\Print** folder.

To permanently save any file to the Mobile Device (printer), save it to the **Temp\Install** folder.

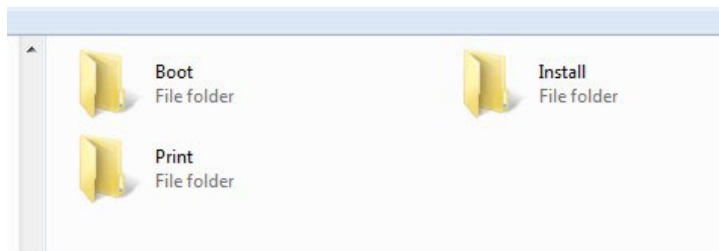
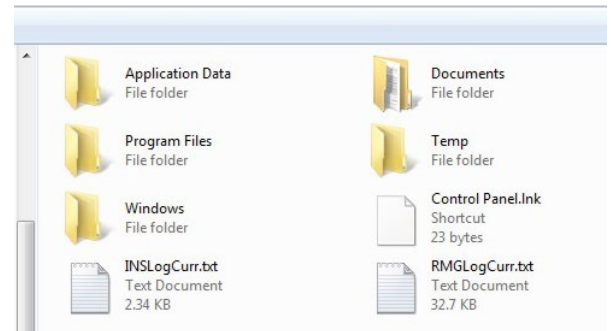

Make sure supplies are loaded, you have a fully charged battery, the printer is connected to a host and ready to receive data, and you have an application in the printer. Refer to your *Operator's Handbook* for more information

Using Fonts with the 6057 Printer

This section is not applicable to the 6059 or 6140 printer. The printer uses standard Windows fonts; however, additional fonts can be downloaded to the printer. See [“Installing Fonts”](#) for more information.

Using Non-Resident Fonts

Within your application, instantiate a new Print class such as rPrint and call a method such as Print to load the non-resident.

Installing Fonts

Follow these steps to install additional Windows fonts to the printer:

1. Make sure the printer is connected via USB and start an Active Sync session.
2. Open the `\WINDOWS\Fonts` folder on your computer.
3. Drag the TrueType® font file (.TTF) from your computer to the Temp\Install folder on the Mobile Device (printer).

Note: Check the `\Windows\Resources\Fonts` folder on the Mobile Device (printer) to make sure the file installed correctly. Do **not** save files directly to this folder.

4. Reference the font’s filename in the LNT file. See [“Defining the Font Tag”](#) for more information about creating a text field with an installed font.

Note: The printer’s software (version 2.0 or higher) supports International (double-byte) fonts. An International TrueType font containing Chinese or Japanese characters may be very large. Make sure the printer has enough memory before installing the font.

Error Reporting with the 6057 Printer

This section is not applicable to the 6059 or 6140 printer. Refer to the *Software Development Kit* (SDK) for more information.

During normal printer operation or while testing a LNT file, you may receive an error message. When an error occurs, a message appears briefly on the display “Press home key to clear the printer error” and a small stop sign icon appears in the Task Bar.

1. Press the **Home** key to show the error message. For example:

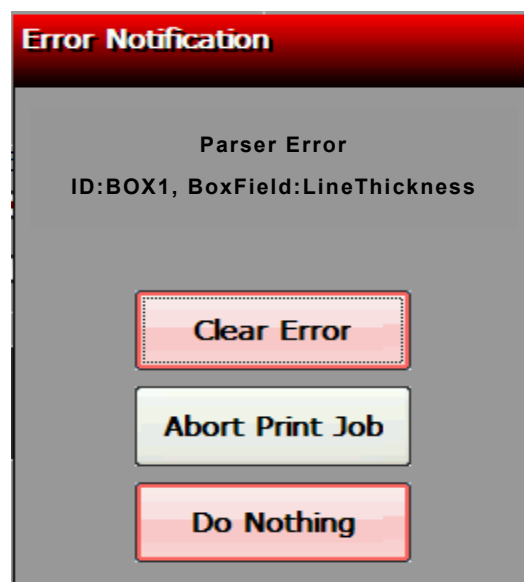

2. Select the option you need: Clear Error (clears the error and continues to feed or print supplies), Abort Print Job (clears the error and cancels the current print job), or Do Nothing (does not clear the error or reprint the job).

The example above, “Parser Error ID:BOX1,BoxField:LineThickness” indicates a parser error in the LNT file. The BOX1 field contains an invalid <LineThickness> tag or is missing the <LineThickness> tag.

Touch **Clear Error**, correct the LNT file, then resend the file to the printer. See “[Defining the Line Thickness Tag](#)” for more information about defining the line thickness of box fields.

See Chapter 6, “[Error Messages](#)” for a listing of error codes.

Note: If there is an error in a LNT file, it does not print.

Enabling the “Field Off Tag” Warning

The printer can display error 614 when a field is positioned outside the printable area. The default does not generate this warning.

To enable:

1. Touch the **Home** key.
2. Select **Printer Config**.
3. Select **General Settings**.
4. Check **Generate Off Tag Warnings**.
5. Touch **OK** when finished.

Note: 614 Errors are not reported when this is not enabled – only correctly positioned fields within the printable area are printed.



Transferring Files to the 6059 Printer

This section is not applicable to the 6057 or 6140 printer. To transfer files to the 6059 printer, use a USB thumb drive or WiFi. These instructions are written for USB data transfer. To transfer files via WiFi from your PC to the 6059 printer, you need a 3rd party application such as TeamViewer.

1. Turn on the printer and wait for it to load.
2. Insert the USB thumb drive into the printer.
3. Open the thumb drive to view files on it.
4. Tap and hold on the filename until you see a check mark to select the file.
5. Tap the more menu (three dots in the upper-right corner).
6. Tap **Copy to...**
7. Select the printer's downloads folder and tap **Copy**.
8. Open the Sample App.
9. Tap the Resource management.
10. Tap the LNT radio button.
11. Navigate to the downloads folder.

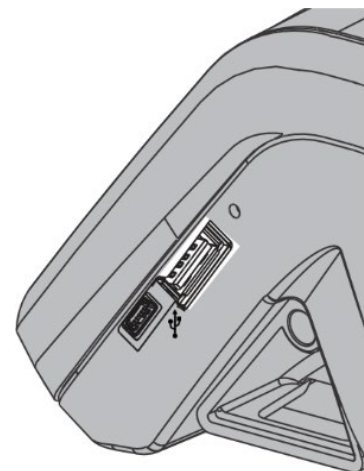

12. Tap the .LNT file you copied. You see "*Adding resource: You have selected the LNT/storage/emulated/0/Download/[FILENAME]. Do you want to add it to the list of the resources?*". Click **OK**.
13. Enter the filename for the LNT file when you see "Please enter the resource alias.", tap **OK**.
14. Then, use the Sample App, Resource Manager to print the LNT file.

Using Fonts with the 6059 Printer

This section is not applicable to the 6057 or 6140 printer.

The 6059 has Roboto and Roboto Bold available for displaying and printing purposes. If these fonts do not fit your needs, find a royalty-free Android font. The font would have to be registered using the API and then load the TTF (?) file using the Sample App.

If using a custom font, make the sure LNT files reference the custom font's name.

Contact Technical Support for more information.

Error Reporting with the 6059 Printer

This section is not applicable to the 6057 or 6140 printer.

The 6059 printer's Sample App will display error codes and provide options to Clear, Abort or Ignore the errors.

Transferring Files to the 6140 Printer

This section is not applicable to the 6057 or 6059 printer. Your application controls the use of LNT, font, or other supported file types.

For example, to add a LNT file (or font file) to your application, use the **SaveResourceAtPath** method, which saves a file to the smart device.

```
[ADResourceManager SaveResourceAtPath:[[NSBundle mainBundle]
pathForResource:@"Markdown.LNT" ofType:nil] type:ADResourceMediaTypeLnt
alias:@"label"];
```

```
[ADResourceManager SaveResourceAtPath:[[NSBundle mainBundle] pathForResource:@"Arial
Bold.ttf" ofType:nil] type:ADResourceMediaTypeFont alias:@"Arial Bold"];
```

For example, to remove a LNT file (or font file) from your application, use the **RemoveResourceOfType** method, which removes a file from the smart device.

Refer to the **Sample Application** (Scan and Print) included with the *iOS Software Development Kit* for more information.

Error Reporting with the 6140 Printer

This section is not applicable to the 6057 or 6059 printer. During normal printer operation, you may receive an error message. When an error occurs, a message appears on the smart device. Follow the instructions on the smart device and press **Feed/Clear Error** on the printer to clear the error and continue.

LNT Design Tips

When creating LNT files, keep in mind the following:

- ◆ The printer uses standard Windows fonts; however, additional fonts can be downloaded to the printer. See [“Installing Fonts”](#) for more information.
- ◆ If setting a value for the font’s pointsizeheight and setting the pointsizewidth to 0, the printed characters will have an optimal aspect ratio of character height-to-width.
- ◆ Use zeros to let the printer determine the width and height for the *<BoundingBox>* tag.
- ◆ If using the wordwrap attribute on a text field, you must specify the width attribute in the *<BoundingBox>* tag.
- ◆ Not all field attributes should be used on the same field – for example, do not use wordwrap with either the underline or the strikethrough attributes.
- ◆ While designing and testing LNT files, we recommend setting the printer to show error messages for fields printing off the label. See [“Enabling the “Field Off Tag” Warning”](#) for more information.

Check these settings if a field prints off the label:

- ◆ x,y points
- ◆ origin point
- ◆ justification
- ◆ field rotation

This chapter provides a reference for defining printer setup XML tags:

- ◆ job settings
- ◆ energy, contrast, print speed, black mark, and on-demand settings
- ◆ quantity
- ◆ image settings.

This chapter also includes information about adjusting the supply position (use backfeed) to reduce the non-print zone.

Defining Printer Setup Tags

Tags *required* for each job are listed at the beginning of each section.

Defining the Job Container (Required)

The job tag is the container for a complete LNT file.

It contains the printer setup XML tags and field setup XML tags for each job.

Syntax <Job>

Example <Job>
 printer setup tags
 field setup tags
 </Job>

The printer’s software supports multiple <Job> tags in one LNT file.

Use version 2.0 or higher (6057), version 1.0 or higher (6059), or version 1.0 or higher (6140).

Defining the LabelSize Tag (Required)

The LabelSize tag defines the length and width of the label.

It contains the following attributes: units, length, and width.

Syntax <LabelSize units="value" length="value" width="value" />

units Unit of measure. Options:
 Inches Inches
 MM Millimeters
 Pixels Pixels

length Length of the label in selected units:

Unit of Measure	Minimum	Maximum	Data Type
Inches	0.55	40.0	Float
Millimeters	14.0	1016.0	Float
Pixels	112	8120	Integer

width

Width of the label in selected units:

Unit of Measure	Minimum	Maximum	Data Type
Inches	1.1	2.0	Float
Millimeters	27.94	50.8	Float
Pixels	224	406	Integer

Example `<LabelSize units="Inches" length="1.0" width="2.0" />`

Defines the label size as 1.0 inch long by 2.0 inches wide.

Defining the Energy Tag (Optional)

The Energy tag defines the printhead energy level. You may need to adjust this value depending on the type of supplies you are using. For example, synthetic supplies require the High energy setting, but standard paper does not.

Syntax `<Energy>value</Energy>`

value

Energy Value. Options:

Normal Use for standard paper. This is the default.

High Use for synthetic supplies.

Example `<Energy>High</Energy>`

Sets the printhead energy to high for synthetic supplies.

Defining the Contrast Tag (Optional)

The Contrast tag defines the print contrast for the job. You may need to adjust this value depending on the type of supplies you are using. For example, synthetic supplies require a higher print contrast, but standard paper requires less contrast.

Note: Solid black print should not exceed 30% on a given square inch of the label, or the printhead life may be decreased.

Syntax `<Contrast>value</Contrast>`

value

Contrast percentage. Do not include the percent sign.

The range is -100 (minimum contrast) to 100 (maximum contrast).

The default is **0** (no contrast adjustment)

Example `<Contrast>35</Contrast>`

Sets the print contrast to 35% for this job.

Defining the PrintSpeed Tag (Optional)

The PrintSpeed tag defines the print speed in inches per second (ips) for the job.

Valid values include: 1.0, 1.5, 2.0, 3.0, 4.0, or 5.0.

It contains the following attribute: *fixed*

Serial bar codes, lines, and graphics print at 2.0 ips. Synthetic supplies and special supplies print at 1.5 ips.

Syntax `<PrintSpeed fixed="value">value</PrintSpeed>`

Fixed The printer prints at the specified setting until the battery drains.
Options:

- 0 False (default)
- 1 True

The Fixed value can be set to 3.0, 4.0 or 5.0 inches per second printing. However, fixed is only recommended for text formats, where print speed is required over print quality.

Example `<PrintSpeed fixed="1">5.0</PrintSpeed>`

Sets the printer's speed to 5.0 ips, but allows the speed to vary from 5.0 ips for serial bar codes, etc.

Defining the UseBlackMark Tag (Optional)

The UseBlackMark tag specifies if the printer uses the black mark sensor to sense supplies.

Syntax `<UseBlackMark>value</UseBlackMark>`

value Use Black Mark Sensor Value. Options:

- 0 Off. Do not use black mark sensor.
- 1 ON. Use the black mark sensor. This is the default.

Example `<UseBlackMark>1</UseBlackMark>`

The printer uses the black mark sensor to calibrate and feed labels.

Defining the UseOnDemand Tag (Optional)

The UseOnDemand tag specifies if the printer uses the on-demand sensor to sense supplies.

Printer	On-Demand Sensor
6057	<i>optional</i>
6059	standard
6140	not available

Syntax `<UseOnDemand>value</UseOnDemand>`

value Use On-demand Sensor Value. Options:

- 0 Off. Do not use on-demand sensor. This is the default.
- 1 ON. Use the on-demand sensor.

Example `<UseOnDemand>0</UseOnDemand>`

The printer does not use the on-demand sensor.

Defining the SensorMode Tag (Optional)

The SensorMode tag specifies which sensor to use, based on your supply type.

Valid values include: "DieCut" and "BlackMark". The default is "DieCut".

Syntax `<UseSensorMode>value</UseSensorMode>`

value Sensor Mode Value. Options:
 DieCut Use the on-demand sensor. This is the default.
 BlackMark Use the black mark sensor.

Example `<UseSensorMode>"DieCut"</UseSensorMode>`

The printer uses the die cut sensor.

Defining the Quantity Tag (Optional)

The Quantity tag specifies the number of labels to print.

Syntax `<Quantity>value</Quantity>`

value Quantity of labels to print. The range is 1 to 999.
 The default is 1.

Example `<Quantity>5</Quantity>`

Prints 5 copies of the label.

Defining the Image Container (Required)

The image tag is a container for all the image tags in the LNT file.

It contains the following attributes: id and version.

Syntax `<Image id="name" version="integer" >`

id The identifier for the image. Any applications using LNT should reference this data. Use any 32-character maximum (UNICODE) string. If you use the same identifier for two LNT images, the previous image is overwritten!

version Integer identifier used to define the revision level of this LNT image.

Example `<Image id="Sale" version="1">
 more image information
 </Image>`

Defining the ImageSize Tag (Required)

The ImageSize tag defines the x and y coordinates for one point on the label, the height and width of the print area and the 0,0 point.

A non-print zone exists on these printers:

for the leading edge = 0.20 inches (or 0.01 inches with adjusting the supply position)

for the trailing edge = 0.05 inches

The leading edge is the edge that exits the printer first.

The ImageSize Tag contains the following attributes: units, x, y, height, width, and origin.

Syntax <ImageSize units="Inches" x="value" y="value" height="value" width="value" origin="value" />

<i>units</i>	Unit of measure. Options: Inches Inches MM Millimeters Pixels Pixels (default)
<i>x</i>	Gives the x-coordinate for one point describing the printing area on the label. This is interpreted as the distance along the x-axis from the Origin point.
<i>y</i>	Gives the y-coordinate for one point describing the printing area on the label. This is interpreted as the distance along the y-axis from the Origin point.
<i>height</i>	The height (in selected units) of the print area. This height is taken from the y value.
<i>width</i>	The width (in selected units) of the print area. This width is taken from the x value.
<i>origin</i>	Describes the corner of the label that is considered the 0, 0 point. All sizing and placement measurements are taken from this point. The default is TopLeft . Options: TopLeft TopRight BottomLeft BottomRight.

Origin in millimeters is shown in Appendix B, "[Design Tools.](#)"

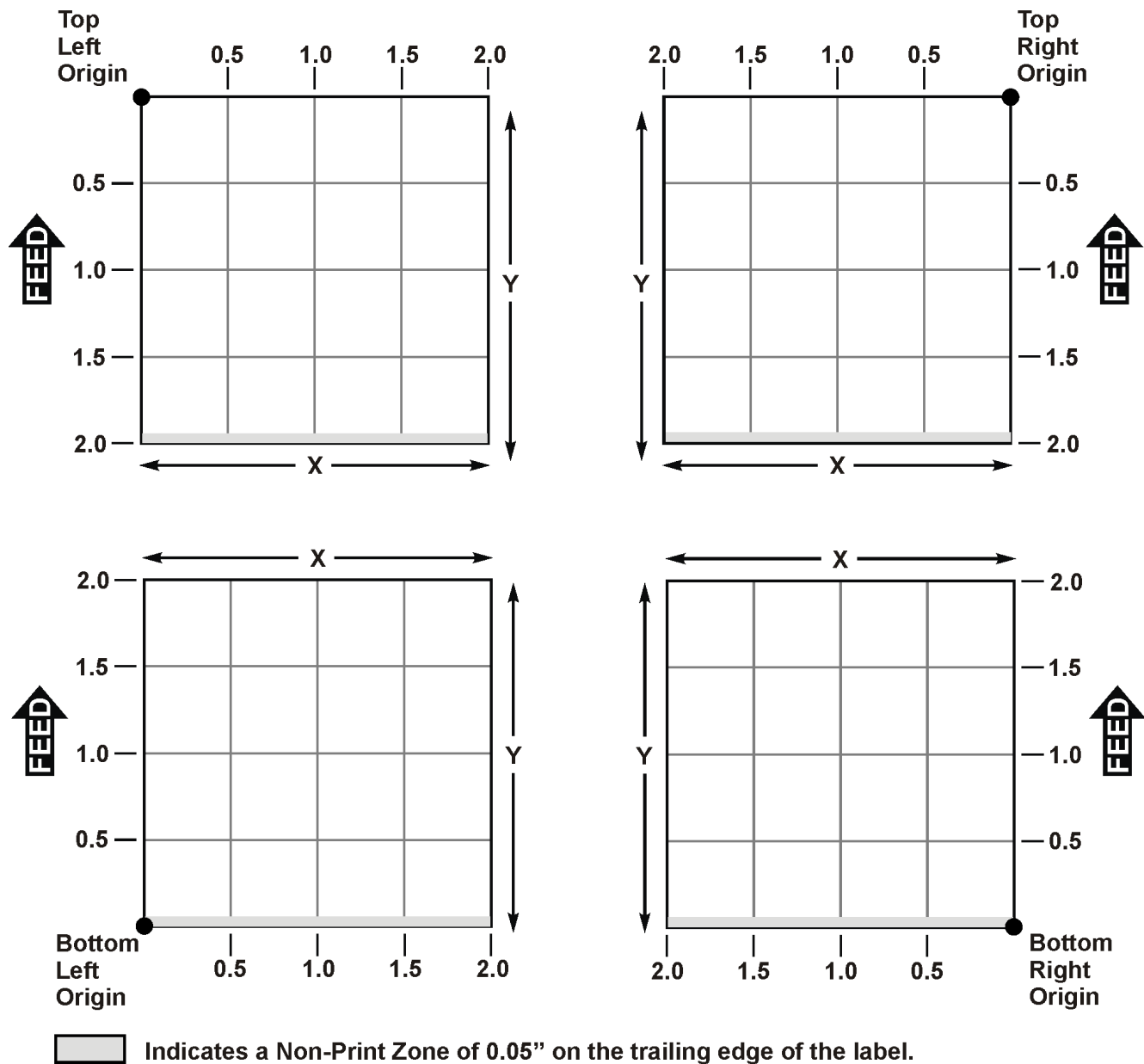

Example `<ImageSize units="Inches" x="0.10" y="0.10" height="1.50" width="1.80" origin="TopLeft" />`

Uses inches for the measurements, sets the x and y axis to 0.10 inches, defines the image size as 1.50 inch long by 1.8 inches wide and sets the image's origin to Top Left.

Adjusting the Supply Position

A non-print zone exists on this printer of 0.20 inches on the leading edge of the supply. The leading edge is the edge that exits the printer first.

You can adjust the supply position to a negative setting (use backfeed) to reduce the size of the non-print zone to 0.01 inches when using Peel mode. The adjustments are in steps (0.00333 inch). The default value is **0**.

Note: Using a negative supply position may increase the possibility of a label jam.

Setting a Negative Supply Position (Using Backfeed on the 6057 Printer)

Using a negative supply position enables backfeed, so the printer must be set for Peel mode. The minimum feed length in peel mode is 0.785 inches. Using a negative supply position may increase the possibility of a label jam.

To adjust the supply position to a negative value:

1. Turn on the printer.
2. Touch the **Home** key.
3. Select **Printer Config** and then **Print Position**.
4. Touch the left arrow to decrease the Supply Position. Start with a value of **-60** and then adjust if necessary.

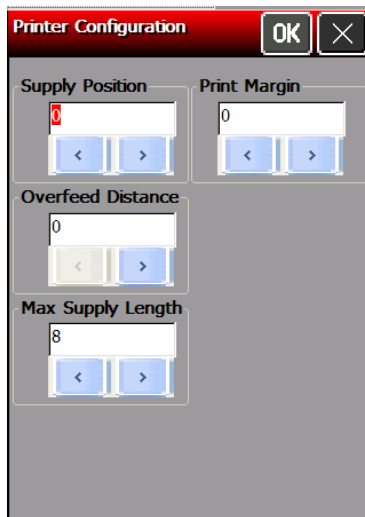
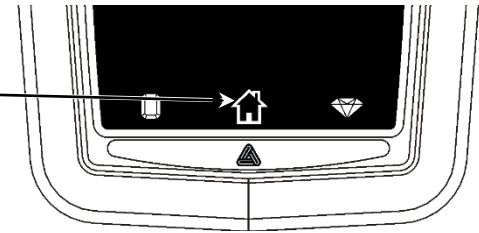

Note: Supply Position and Overfeed Distance are in steps; the Print Margin adjustment is in pixels (0.00049 inch). One pixel is equivalent to one dot.

5. Touch **OK** when finished.

Setting the Supply Position on the 6059 Printer

Open the *Printer Setup Application* installed on the printer. Select the Supply menu, then adjust the supply position within the range of -99 to 99. The default is 0.

DEFINING FIELD SETUP XML TAGS

This chapter provides a reference for defining the field setup XML tags, which is the label's layout:

- ◆ text and constant text fields
- ◆ bar code fields
- ◆ line, box, ellipse, and graphic fields.

Defining the Fields Container (Required)

The Fields tag is a container for all field setup XML tags (label layout) in the LNT file. There must be one of these within the `</Image>` tag.

It contains the following attribute: `count`.

Syntax `<Fields count="value">`
 `field information`
 `</Fields>`

count The number of fields on the label. Use an integer from 1 to 65535. Include Line, Box, Ellipse and graphic fields in this total.

Example `<Fields count="4">`
 `field information`
 `</Fields>`

Specifies the label contains four fields.

Defining the TextField (Required)

The TextField tag specifies how the text field appears on the label.

It contains the following attribute: `id`.

Syntax `<TextField id="value" >`
 `text field information`
 `</TextField>`

id The identifier (name) of the text field. Any applications using LNT should reference this data. Use any 32-character maximum (UNICODE) string. **Do not** use the same name for two fields or an error occurs!

Example `<TextField id="Price" >`
 `text field information`
 `</TextField>`

Specifies a text field called "Price" in the LNT file.

Defining the BoundingBox Tag (Required for non-barcode fields)

The BoundingBox tag defines the area on the label where the field appears. Each non-barcode field on a label must fit inside a bounding box. The bounding box is represented by the dotted lines in the following graphic.

It contains the following attributes: units, x, y, height, and width.

For text fields, the bounding box can also contain the shape tag and the line thickness tag. See “Defining the Shape Tag” and “Defining the Line Thickness.”

Syntax `<BoundingBox units="value" x="value" y="value" height="value" width="value">`
 `bounding box information </ BoundingBox >`

units Unit of measure. Options:

Inches Inches
MM Millimeters
Pixels Pixels (default)

x X-Coordinate of the Origin
 corner of the bounding box.
 Use an integer or float (in
 selected units) that is less than
 the width.

y Y-Coordinate of the Origin
 corner of the bounding box.
 Use an integer or float (in
 selected units) that is less than the height.

height The height (in selected units) of the print area. Use an integer or
 float value that is less than the image height. Use zero to let the
 printer determine the height.

width The width (in selected units) of the print area. Use an integer or
 float value that is less than the image width. Use zero to let the
 printer determine the height.

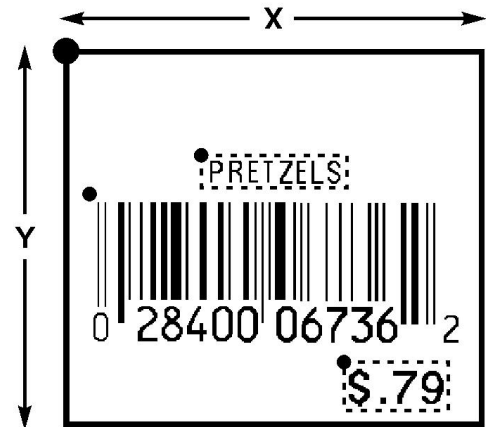

Example `<BoundingBox units="Inches" x="0.70" y="0.30" height="0.20" width="0.80">`

Sets the coordinates for the text field's bounding box and specifies the height as 0.20 inches and the width as 0.80 inches.

Defining the Shape Tag (Optional)

The Shape tag defines the shape that encloses the text. Its valid values are Box and Ellipse. The default is Box. Use the Shape tag to fit text within a pre-printed or elliptically shaped area.

Syntax `<Shape>value</Shape>`

shape Shape Value. Options:

Box Defines the text field's data area within a rectangular
 shape. This is the default.

Ellipse Defines the text fields's data area within an elliptical
 shape.

Example `<Shape>Ellipse</Shape>`

Defines the text box to have an elliptical shape.

Defining the Line Thickness Tag (Optional)

The LineThickness tag defines the thickness of the Shape tag's lines. The default value for this tag is 0, in which case there will be no visible shape enclosing the text.

Valid values include: An integer or float (in selected units).

It contains the following attribute: units.

Syntax `<LineThickness units="value">value</LineThickness>`
 units Unit of measure. Options:
 Inches Inches
 MM Millimeters
 Pixels Pixels (default)

Example `<LineThickness units="Inches">0.05</LineThickness>`

Defines the shape's lines as 0.05 inches thick.

Example `<BoundingBox units="Inches" x="0.70" y="0.30" height="0.20" width="0.80">`
 `<Shape>Ellipse</Shape>`
 `<LineThicknes units="Pixels">1</LineThickness>`
 `</BoundingBox>`

Sets the coordinates for the text field's bounding box and specifies the height as 0.20 inches and the width as 0.80 inches. The text is enclosed within an elliptical shaped bounding box with a 1-pixel thick border.

Defining the Data Tag (Required)

The Data tag specifies how many characters are expected in the field. It also can contain any fixed data you want to print in the text field.

If this field is *Volatile*, *min* and *max* are required attributes. We recommend setting the *min* and *max* attributes.

Valid values include: Any Unicode string less than 2K characters.

It contains the following attributes: min and max.

Syntax `<Data min="value" max="value">value</Data>`
 min Minimum number of characters in the field.
 max Maximum number of characters in the field.

To print special characters, use the tilde with the decimal ASCII equivalent. For example, to print the Euro (€) symbol, use ~219 (using Code Page 100). You must use a font that supports the code page selected. Arial or a similar TrueType® font supports Code Page 100.

Example `<Data min="1" max="10" />`

Specifies the data length from 1 to 10 characters in the text field.

Example `<Data>Sale!</Data>`

Prints the fixed data **Sale!** in the text field.

Example `<Data>~219 30 or $39.40</Data>`

Prints the fixed data **€ 30 or \$39.40** in the text field. ">

Defining the Volatile Tag (Required)

The Volatile tag specifies whether the field's data is set at creation or print time. For data set at print time, the user enters the data.

Syntax <Volatile>value</Volatile>

value Volatile Value. Options:

- 0 The field's data is defined when created (fixed). To create fixed data on a label, set volatile to 0 and add a <Data> tag with the fixed data to print on each label.
- 1 The field's data is set at print time (variable). This is the default. When volatile is set to 1, the <Data> tag must specify min and max attributes.

Example <Volatile>1</Volatile>

The data for this field is entered at print time.

Example <Volatile>0</Volatile>
 <Data>Dept. 7512</Data>

Prints the fixed data **Dept. 7512** in the text field.

Example <Volatile>1</Volatile>
 <Data min="1" max="10" />

The data for this field is entered at print time and must be at least one character but cannot exceed 10 characters.

Defining the Rotation Tag (Optional)

The Rotation tag selects the rotation of the bounding box in degrees. Rotation occurs from the origin point of the bounding box.

Syntax <Rotation>value</Rotation>

value Rotation Value. Options:

- 0 No rotation. This is the default.
- 90 90° rotation
- 180 180° rotation
- 270 270° rotation

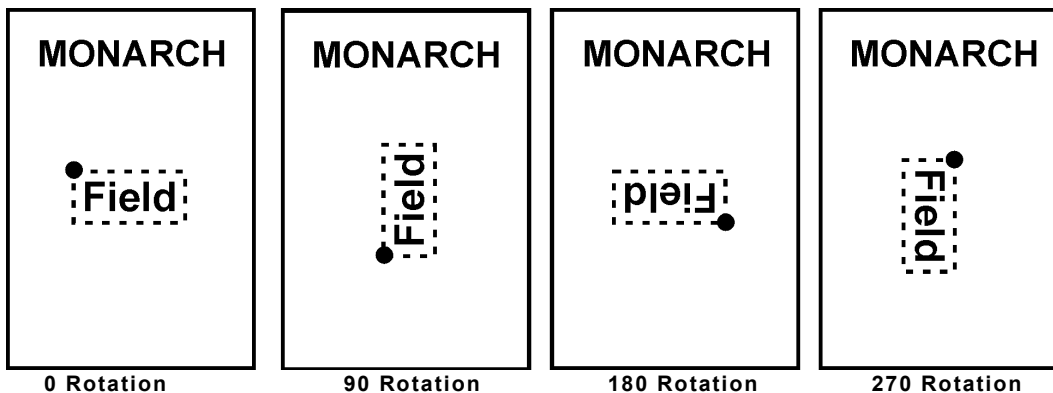

Example <Rotation>180</Rotation>

The printed field is rotated 180° on the label.

Defining the DrawMode Tag (Optional)

The DrawMode tag specifies the transparency of the bounding box.

Field placement in the file is an important consideration when using DrawMode. If a line field is defined before the text field, the line field may be blocked out, depending on the text field's DrawMode. If a line field is defined after the text field, the line field is not blocked out by the selected DrawMode.

Syntax <DrawMode>value</DrawMode>

value

DrawMode Value. Options:

Transparent The bounding box does not block out (or “erase”) existing fields except where data appears in the bounding box. This is the default.

Opaque The bounding box blocks out (“erases”) existing fields below it.

XOR The data in the bounding box appears inverted (white image on black background).

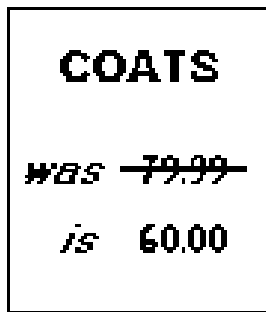

Transparent

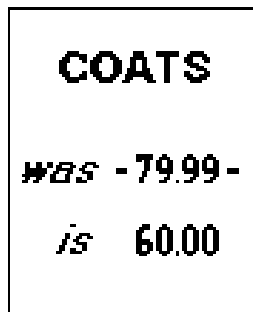

Opaque

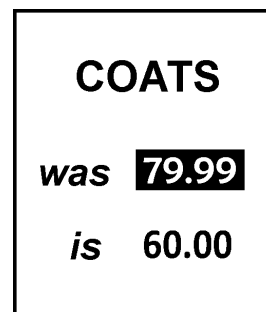

XOR

Example <DrawMode>Opaque</DrawMode>

Sets the text field's DrawMode to opaque, which erases any other fields on the label with the same coordinates.

Defining the Font Tag (Optional)

The Font tag specifies the font to use for this text field.

Valid values include: Any UNICODE string containing less than 256 characters. The default is **Arial**. See "[International Font Sample](#)" for a LNT file using an Asian font.

It contains the following attributes: *pointsizeheight*, *pointsizewidth*, *italics*, *wordwrap*, *underline*, *strikethrough*, *mpclstyle*, *intercharactergap*, and *weight*.

Note: *Italics* is an available attribute; however, for optimal print quality select a font that is already italicized.

Syntax `Name`

pointsizeheight The height point size of the font. The default is **10**.

pointsizewidth The width point size of the font. The default is **0**.

If *pointsizeheight* and *pointsizewidth* are not set to the same point size, the printed characters look tall and thin or short and thick, which allows for greater flexibility in the appearance of the font.

If you set a value for *pointsizeheight* and set *pointsizewidth* to 0, the printed characters will have optimal aspect ratio of character height-to-width.

italics Boolean value describing if the text is italicized. The default is **0**. Options:

- 0 Not Italicized
- 1 Italicized

wordwrap Boolean value describing if wrapping text is enabled. The default is **0**. See "[Example Text Field with Wordwrap](#)" for more information. Options:

- 0 Not enabled
- 1 Allows word wrap.

When using *wordwrap*, you must specify the width attribute in the *<BoundingBox>* tag.

Do not use *wordwrap* with either the *underline* or the *strikethrough* attributes.

underline Boolean value describing if the text is underlined. The default is **0**. Options:

- 0 Not underlined
- 1 Underlined. **Do not** use *underline* with the *wordwrap* attribute.

strikethrough Boolean value describing if the text appears with a line through it. The default is **0**. Options:

- 0 No Strikethrough
- 1 Text appears with a line through it. **Do not** use *strikethrough* with the *wordwrap* attribute.

<i>intercharactergap</i>	An integer defining the number of points between characters. The default is 0 .
<i>lineheight</i>	An integer defining the distance between the adjacent lines of word-wrapped text. This parameter is defined in “Em” units, which signify the ratio of the distance between the baselines of two adjacent lines and the height of the text line. The value should be equal to or larger than one. A larger value produces larger gap in between lines of word-wrapped text. The value 1 indicates no space between lines of word-wrapped text. The default value is 1.2 .
<i>weight</i>	The weight (boldness) of the font. Options: <ul style="list-style-type: none"> 0 FW_DEFAULT 100 FW_THIN 200 FW_EXTRALIGHT 200 FW_ULTRALIGHT 300 FW_LIGHT 400 FW_NORMAL (default) 400 FW_REGULAR 500 FW_MEDIUM 600 FW_SEMIBOLD 600 FW_DEMIBOLD 700 FW_BOLD 800 FW_EXTRABOLD 800 FW_ULTRABOLD 900 FW_HEAVY 900 BLACK
<i>mpclstyle</i>	Boolean value describing if tilde sequences are replaced with their special character equivalents. The default is 0 . See “Example Text Field with MPCLSTYLE” for more information. Options: <ul style="list-style-type: none"> 0 Do not replace tilde sequences 1 Replace tilde sequences
<i>codepage</i>	Code page/symbol set. The default is 0 . Options: <ul style="list-style-type: none"> 0 Internal 100 Macintosh 101 Wingdings 102 Unicode 103 BIG5 for Unicode 104 GB2312 for Unicode 105 Code page 932/SJIS/Japanese 106 Code page 936/GB2312/Simplified Chinese 107 Code page 950/BIG5/Traditional Chinese 108 KSC5601/Korean 110 Unicode UTF-8 111 UTF-8 (Input processed left-to-right) 112 UTF-8 (Input processed right-to-left) <p>See Appendix C, “Codepages” for more information.</p>

Example Text Field with Wordwrap

```
<TextField id="item">  
<Volatile>0</Volatile>  
<BoundingBox units="Inches" x="0.35" y="0.25" height="0" width="1.25" />  
<Font pointsizeheight="9.0" pointsizewidth="9.0" wordwrap="1" >Arial</Font>  
<VerticalJustification>Bottom</VerticalJustification>  
<HorizontalJustification>Left</HorizontalJustification>  
<Data>PRETZELS with butter and sea salt.</Data>  
</TextField>
```



The text field "PRETZELS with butter and sea salt." has word-wrapping enabled. The dotted line represents the bounding box with a width of 1.25 inches. Arial Bold font is used with a height and width of 9 points.

Example Text Field with MPCLSTYLE

```
<TextField id="item">  
<Volatile>0</Volatile>  
<BoundingBox units="Inches" x="0.35" y="0.25" height="0" width="1.25" />  
<Font pointsizeheight="9.0" pointsizewidth="9.0" mpclstyle="1" codepage="100" >Arial</Font>  
<VerticalJustification>Bottom</VerticalJustification>  
<HorizontalJustification>Left</HorizontalJustification>  
<Data>~219 35</Data>  
</TextField>
```

The data in this field prints as € 35 since ~219 is the tilde sequence for the Euro symbol.

Defining the VerticalJustification Tag (Optional)

The VerticalJustification tag describes how text fits vertically in the field.

Syntax <VerticalJustification>value</VerticalJustification>

value

VerticalJustification Value. Options:

Top Vertically align text at the top of the field. This is the default.

Center Vertically align text in the center of the field.

Bottom Vertically align text at the bottom of the field.

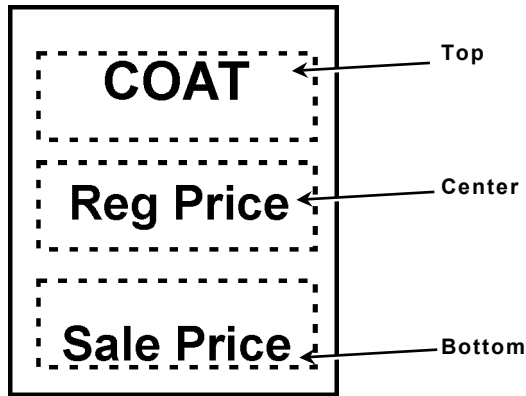

Example <VerticalJustification>Bottom</VerticalJustification>

Vertically justifies the text at the bottom of the field.

Defining the HorizontalJustification Tag (Optional)

The HorizontalJustification tag describes how text fits horizontally in the field.

Center aligns the text based on the Bounding Box's *width* value. If the width is not defined or set to 0, the text is centered based on the Bounding Box's *x* value.

Syntax <HorizontalJustification>value</HorizontalJustification>

value

HorizontalJustification Value. Options:

Left Horizontally align text to the left in the field. This is the default.

Center Horizontally align text in the center of the field.

Right Horizontally align text to the right in the field.

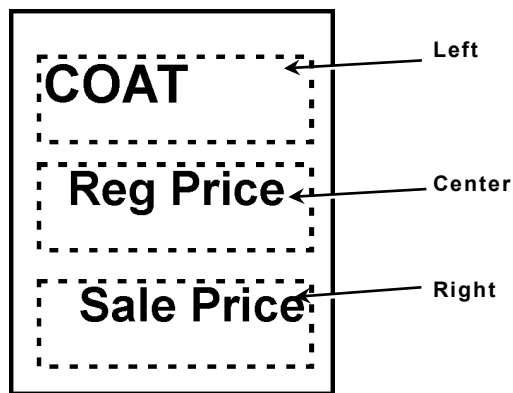

Example <HorizontalJustification>Right</HorizontalJustification>

Horizontally aligns the text on the right side in the field.

Defining the BackgroundColor Tag (Optional)

The BackgroundColor tag sets the background color for the field to black or white.

Syntax <BackgroundColor>value</BackgroundColor>

value BackgroundColor Value. Options:
 Black, White, or hex encoded RGB value in the format #RRGGBB.
 The only valid hex values are #FFFFFF (white) and #000000
 (black). The default is White.

Example <BackgroundColor>Black</BackgroundColor>

Sets the background color of the field to black.

Defining the ForegroundColor Tag (Optional)

The ForegroundColor tag sets the text's color in the field to black or white.

Syntax <ForegroundColor>value</ForegroundColor>

value ForegroundColor Value. Options:
 Black, White, or hex encoded RGB value in the format #RRGGBB.
 The only valid hex values are #FFFFFF (white) and #000000
 (black). The default is Black.

Example <ForegroundColor>White</ForegroundColor>

Sets the text's color to white.

Defining the BarcodeField (Required)

The BarcodeField tag specifies how the bar code field appears on the label.

It contains the following attribute: *id*.

Syntax <BarcodeField id="value" >
 bar code field information
 </BarcodeField>

id The identifier (name) of the bar code field. Any applications using
LNT should reference this data. Use any 32-character maximum
(UNICODE) string. Do not use the same name for two fields or an
error occurs!

Example <BarcodeField id="UPCA" >
 bar code field information
 </BarcodeField>

Specifies a bar code field called "UPCA" in the LNT file.

Defining the Data Tag (Required)

The Data tag specifies how many characters are expected in the field. It can also contain the fixed bar code data. We recommend setting the *min* and *max* attributes.

Note: If this field is *Volatile*, *min* and *max* are required attributes.

Valid values include: Any Unicode string less than 2K characters.

It contains the following attributes: *min* and *max*.

Syntax <Data min="value" max="value">value</Data>

min Minimum number of characters in the field.

max Maximum number of characters in the field.

Example <Data min="1" max="12" />

Specifies the data length from 1 to 12 characters in the bar code field.

Example <Data>012345678901</Data>

Prints the fixed data **0123456789012** in the bar code field.

Defining the Volatile Tag (Required)

The Volatile tag specifies whether the field's data is set at creation or print time. For data set at print time, a user enters the data.

Syntax <Volatile>value</Volatile>

value Volatile Value. Options:

 0 The field's data is defined when created (fixed). To create fixed data on a label, set volatile to 0 and add a <Data> tag with the fixed data to print on each label.

 1 The field's data is set at print time (variable). This is the default. When volatile is set to 1, the <Data> tag must specify min and max attributes.

Example <Volatile>1</Volatile>

The data for this field is entered at print time.

Note: To create a fixed bar code on a label, set volatile to 0 and add a <Data> tag with the fixed data for the bar code.

Example <Volatile>0</Volatile>
 <Data>012345678901</Data>

Prints the fixed data **012345678901** in the specified bar code field (all required bar code attributes are not shown).

Defining the Origin Tag (Required)

The Origin tag defines the corner of the bar code.

It contains the following attributes: units, justification, x, and y.

Syntax <Origin units="value" justification="value" x="value" y="value" />

units Unit of measure. Options:
Inches Inches
MM Millimeters
Pixels Pixels (default)

justification Justification of the bar code in respect to the origin location.
Options:
Left (default)
Center
Right

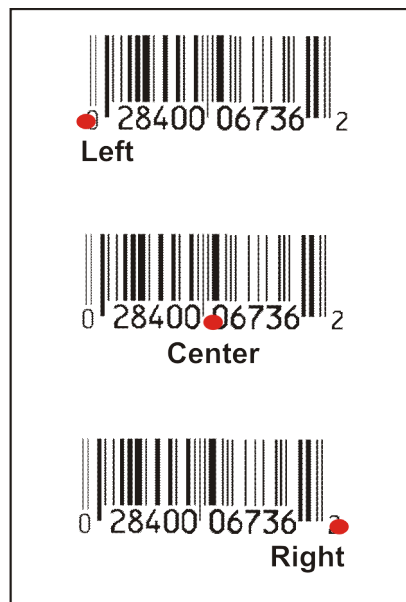

Note: Starting at the specified x,y coordinates, the bar code fills in to the right with Left justification; to the left and right with Center justification; to the left with Right justification.

x X-Coordinate of the corner of the bar code. An integer or float (in selected units) that is less than the width.

y Y-Coordinate of the corner of the bar code. An integer or float (in selected units) that is less than the height.

Example <Origin units="Inches" justification="Left" x="0.05" y="0.25" />

Defines the left corner of the bar code starting on the x axis at 0.05 and the y axis at 0.25.

Example <Origin units="Inches" justification="Center" x="0.05" y="0.25" />

Defines the center of the bar code starting on the x axis at 0.05 and the y axis at 0.25.

Defining the BarHeight Tag (Required)

The BarHeight tag defines the bar code's height (in selected units).

Valid values include: An integer or float greater than zero and less than the `<ImageHeight>` minus the `<Origin>` value in selected units.

It contains the following attribute: units.

Syntax `<BarHeight units="value">value</BarHeight>`
 units Unit of measure. Options:
 Inches Inches
 MM Millimeters
 Pixels Pixels (default)

Example `<BarHeight units="Inches">0.50</BarHeight>`

Defines the bar code's height as 0.50 inches.

Defining the Type Tag (Required)

Defines the bar code type for this field.

Valid values include: Any Unicode string of less than 256 characters, including:

upca, upca+2, upca+5, upce, upce1, upce+2, upce+5, ean8, ean8+2, ean8+5, ean13, ean13+2, ean13+5, i2of5, itf, code39, code93, code2of5, codabar, nw7, msi, code128, code128a, code128b, code128c, pdf417, micropdf417, maxicode, code16, data matrix, quick response, qr, postnet, gs1databar, gs1, or rss.

Syntax `<Type>value</Type>`

Example `<Type>upca</Type>`

Defines the bar code type as upca.

Defining the Orientation Tag (Optional)

The Orientation tag selects the rotation of the bar code in degrees.

Valid values include: 0, 90, 180, and 270. The default is 0.

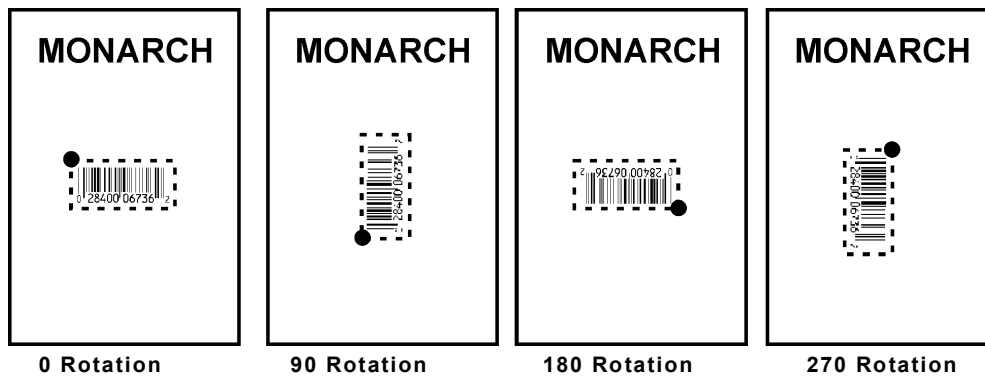

Syntax `<Orientation>value</Orientation>`

Example `<Orientation>90</Orientation>`

Rotates the bar code 90° on the label.

Defining the Options Tag (Optional)

The Options tag defines any options supported by the bar code's `<type>`. For more information about each bar code's supported options, see Chapter 4, "[Defining Bar Code Options](#)" for more information.

Defining the LineField Tag (Required)

The LineField tag defines a line. Use lines to form borders and mark out original prices.

Note: The solid black print can not exceed 30 percent of any given square inch of the label.

It contains the following attribute: id.

Syntax <LineField id="value" >
 line field information
 </LineField>

id The identifier (name) of the line field. Any applications using LNT should reference this data. Use any 32-character maximum (UNICODE) string. Do not use the same name for two fields or an error occurs!

Example <LineField id="Border1" >
 line field information
 </LineField>

Specifies a line field called "Border1" in the LNT file.

Defining the Offset1 Tag (Required)

The Offset1 tag defines the first point of a line segment.

It contains the following attributes: units, x, and y.

Syntax <Offset1 units="value" x="value" y="value" />

units Unit of measure. Options:
 Inches Inches
 MM Millimeters
 Pixels Pixels (default)

x An integer or float (in selected units) that is less than the <ImageWidth>.

y An integer or float (in selected units) that is less than the <ImageHeight>.

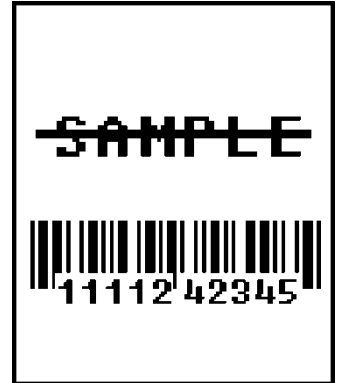

Example <Offset1 units="Inches" x="0.25" y="0.15" />

Sets the starting point for the line on the x axis at 0.25 and the y axis at 0.15.

Defining the Offset2 Tag (Required)

The Offset2 tag defines the ending point of a line segment.

It contains the following attributes: units, x, and y.

To create horizontal lines, keep the y values the same and only change the x values.

To create vertical lines, keep the x values the same and only change the y values.

Syntax `<Offset2 units="value" x="value" y="value" />`

<i>units</i>	Unit of measure. Options: Inches Inches MM Millimeters Pixels Pixels (default)
<i>x</i>	An integer or float (in selected units) that is less than the <ImageWidth>.
<i>y</i>	An integer or float (in selected units) that is less than the <ImageHeight>.

Example `<Offset2 units="Inches" x="0.25" y="0.75" />`

Sets the ending point for the line on the x axis at 0.25 and the y axis at 0.75.

Example `<Offset1 units="Inches" x="0.25" y="0.15" />`
 `<Offset2 units="Inches" x="0.75" y="0.15" />`

Creates a 0.5-inch horizontal line beginning at 0.25 inches and ending at 0.75 inches on the y-axis at 0.15 inches.

Defining the Thickness Tag (Required)

The Thickness tag defines the line thickness.

Valid values include: An integer or float (in selected units).

It contains the following attribute: units.

Syntax `<Thickness units="value">value</Thickness>`

<i>units</i>	Unit of measure. Options: Inches Inches MM Millimeters Pixels Pixels (default)
--------------	---

Example `<Thickness units="Inches">0.10</Thickness>`

Defines a line 0.10 inches thick.

Defining the BoxField Tag (Required)

The BoxField tag defines a box. Use boxes to form borders or highlight items of interest.

Note: The solid black print can not exceed 30 percent of any given square inch of the label.

It contains the following attribute: *id*.

Syntax <BoxField id="value" >
 box field information
 </BoxField>

id The identifier (name) of the line field. Any applications using LNT should reference this data. Use any 32-character maximum (UNICODE) string. Do not use the same name for two fields or an error occurs!



Example <BoxField id="Box1" >
 box field information
 </BoxField>

Specifies a box field called "Box1" in the LNT file.

Defining the Box Tag (Required)

The Box tag specifies the coordinates for the box field on the label.

It contains the following attributes: *units*, *x*, *y*, *height*, and *width*.

Syntax <Box units="value" x="value" y="value" height="value" width="value" />

units Unit of measure. Options:

Inches Inches

MM Millimeters

Pixels Pixels (default)

x X-Coordinate of the corner of the bounding box. Use an integer or float (in selected units) that is less than the width.

y Y-Coordinate of the corner of the bounding box. Use an integer or float (in selected units) that is less than the height.

height The height (in selected units) of the print area. Use an integer or float value greater than zero and less than the image height.

width The width (in selected units) of the print area. Use an integer or float value greater than zero and less than the image width.

Example <Box units="Inches" x="0.25" y="0.15" height="0.50"
 width="0.50" />

Defines a box that begins on the x axis at 0.25 and the y axis at 0.15; the box's height and width are 0.50 inches.

Defining the Line Thickness Tag (Required)

The LineThickness tag defines the thickness of the box's lines.

Valid values include: An integer or float (in selected units).

It contains the following attribute: units.

Syntax <LineThickness units="value">value</LineThickness>

<i>units</i>	Unit of measure. Options:
	Inches Inches
	MM Millimeters
	Pixels Pixels (default)

Example <LineThickness units="Inches">0.05</LineThickness>

Defines the box's lines as 0.05 inches thick.

Defining the DrawMode Tag (Optional)

The DrawMode tag specifies the transparency of the bounding box.

Valid values include: Transparent, Opaque, and XOR. The default is **Transparent**.

Transparent	The bounding box does not block out (or "erase") existing fields except where data appears in the bounding box.
Opaque	The bounding box blocks out ("erases") existing fields below it.
XOR	The data in the bounding box appears inverted (white image on a black background).

Syntax <DrawMode>value</DrawMode>

Example <DrawMode>Opaque</DrawMode>

Sets the box field's DrawMode to opaque, which erases any other fields on the label with the same coordinates.

Defining the LineColor Tag (Optional)

The LineColor tag sets the line's color to black or white.

Valid values include: Black, White, or hex encoded RGB value in the format #RRGGBB. The only valid hex values are #FFFFFF (white) and #000000 (black). The default is **Black**.

Syntax <LineColor>value</LineColor>

Example <LineColor>Black</LineColor>

Sets the line's color to black.

Defining the FillColor Tag (Optional)

The FillColor tag sets the fill color for the box to black or white.

Valid values include: Black, White, or hex encoded RGB value in the format #RRGGBB. The only valid hex values are #FFFFFF (white) and #000000 (black). The default is **Black**.

Syntax <FillColor>value</FillColor>

Example <FillColor>Black</FillColor>

Sets the box's fill color to black.

Defining an EllipseField (Required)

The EllipseField tag defines a circle or an oval. Use ellipses to form borders or highlight items of interest.

It contains the following attribute: *id*.

Syntax <EllipseField *id*="value" >
 ellipse field information
 </EllipseField>

id The identifier (name) of the field. Any applications using LNT should reference this data. Use any 32-character maximum (UNICODE) string. Do not use the same name for two fields or an error occurs!



Example <EllipseField *id*="Circle1" >
 ellipse field information
 </EllipseField>

Specifies an ellipse field called "Circle1" in the LNT file.

Defining the BoundingBox Tag (Required)

The BoundingBox tag defines the area on the label where the ellipse field appears. Each field on a label must fit inside a bounding box.

It contains the following attributes: *units*, *x*, *y*, *height*, and *width*.

Syntax <BoundingBox *units*="value" *x*="value" *y*="value" *height*="value"
 width="value" />

units Unit of measure. Options:
 Inches Inches
 MM Millimeters
 Pixels Pixels (default)

x X-Coordinate of the Origin corner of the bounding box. Use an integer or float (in selected units) that is less than the width.

y Y-Coordinate of the Origin corner of the bounding box. Use an integer or float (in selected units) that is less than the height.

height The height (in selected units) of the print area. Use an integer or float value that is less than the image height. Use zero to let the printer determine the height.

width The width (in selected units) of the print area. Use an integer or float value that is less than the image width. Use zero to let the printer determine the width.

Example <BoundingBox *units*="Inches" *x*="0.70" *y*="0.30" *height*="0.20" *width*="0.80" />

Sets the coordinates for the ellipse field's bounding box and specifies the height as 0.20 inches and the width as 0.80 inches.

Defining the Line Thickness Tag (Required)

The Line Thickness tag defines the thickness of the ellipses' lines.

Valid values include: An integer or float (in selected units).

It contains the following attribute: units.

Syntax `<LineThickness units="value">value</LineThickness>`

units	Unit of measure. Options:
	Inches Inches
	MM Millimeters
	Pixels Pixels (default)

Example `<LineThickness units="Inches">0.10</LineThickness>`

Defines the ellipses' lines as 0.10 inches thick.

Defining the DrawMode Tag (Optional)

The DrawMode tag specifies the transparency of the bounding box.

Valid values include: Transparent, Opaque, and XOR. The default is **Transparent**.

Transparent	The bounding box does not block out (or "erase") existing fields except where data appears in the bounding box.
Opaque	The bounding box blocks out ("erases") existing fields below it.
XOR	The data in the bounding box appears inverted (white image on a black background).

Syntax `<DrawMode>value</DrawMode>`

Example `<DrawMode>Opaque</DrawMode>`

Sets the box field's DrawMode to opaque, which erases any other fields on the label with the same coordinates.

Defining the LineColor Tag (Optional)

The LineColor tag sets the line's color to black or white.

Valid values include: Black, White, or hex encoded RGB value in the format #RRGGBB. The only valid hex values are #FFFFFF (white) and #000000 (black). The default is **Black**.

Syntax `<LineColor>value</LineColor>`

Example `<LineColor>Black</LineColor>`

Sets the line's color to black.

Defining the FillColor Tag (Optional)

The FillColor tag sets the fill color for the ellipse to black or white.

Valid values include: Black, White, or hex encoded RGB value in the format #RRGGBB. The only valid hex values are #FFFFFF (white) and #000000 (black). The default is **Black**.

Syntax `<FillColor>value</FillColor>`

Example `<FillColor>Black</FillColor>`

Sets the ellipse's fill color to black.

Defining a GraphicField (Required)

The GraphicField tag defines a graphic. The following graphic file types are supported: BMP, GIF, JPG, and PNG.

It contains the following attribute: `id`.

Syntax `<GraphicField id="value" >`
 `graphic field information`
 `</GraphicField>`

id The identifier (name) of the field. Any applications using LNT should reference this data. Use any 32-character maximum (UNICODE) string. Do not use the same name for two fields or an error occurs!



Example `<GraphicField id="Logo1" >`
 `graphic field information`
 `</GraphicField>`

Specifies a graphic field called "Logo1" in the LNT file.

Defining the Volatile Tag (Required)

The Volatile tag specifies whether the field's data is set at creation or print time. For data set at print time, the user enters the data.

Valid values include: 0 (set at creation) or 1 (set at print time). The default is 1.

Syntax `<Volatile>value</Volatile>`

Example `<Volatile>1</Volatile>`

The data for this field is entered at print time.

Defining the BoundingBox Tag (Required)

The BoundingBox tag defines the area on the label where the field appears. Each field on a label must fit inside a bounding box.

It contains the following attributes: `units`, `x`, `y`, `height`, and `width`.

Syntax `<BoundingBox units="value" x="value" y="value" height="value"`
 `width="value" />`

units Unit of measure. Options:
 Inches Inches
 MM Millimeters
 Pixels Pixels (default)

x X-Coordinate of the Origin corner of the bounding box. Use an integer or float (in selected units) that is less than the width.

y Y-Coordinate of the Origin corner of the bounding box. Use an integer or float (in selected units) that is less than the height.

height The height (in selected units) of the print area. Use an integer or float value that is less than the image height. Use zero to let the printer determine the height.

width The width (in selected units) of the print area. Use an integer or float value that is less than the image width. Use zero to let the printer determine the width.

Example `<BoundingBox units="Inches" x="0.70" y="0.30" height="0.20" width="0.80" />`

Sets the coordinates for the graphic field's bounding box and specifies the height as 0.20 inches and the width as 0.80 inches.

Defining the Data Tag (Required)

The Data tag contains the filename of the graphic. The following graphic file types are supported: BMP, GIF, JPG, and PNG. Save the graphic to the **Temp\Install** folder on the Mobile Device (printer).

Note: Check the **\Windows\Resources\Images** folder on the Mobile Device (printer) to make sure the file installed correctly. Do **not** save files directly to this folder.

Valid values include: Any Unicode string less than 2K characters.

Syntax `<Data>value</Data>`

Example `<Data>OurLogo</Data>`

Prints the graphic named OurLogo.bmp in the graphic field.

Defining the DrawMode Tag (Optional)

The DrawMode tag specifies the transparency of the bounding box.

Valid values include: Transparent, Opaque, and XOR. The default is **Transparent**.

Transparent The bounding box does not block out (or "erase") existing fields except where data appears in the bounding box.

Opaque The bounding box blocks out ("erases") existing fields below it.

XOR The data in the bounding box appears inverted (white image on a black background).

Syntax `<DrawMode>value</DrawMode>`

Example `<DrawMode>Opaque</DrawMode>`

Sets the graphic field's DrawMode to opaque, which erases any other fields on the label with the same coordinates.

Defining the VerticalJustification Tag (Optional)

The VerticalJustification tag describes how text fits vertically in the field.

Valid values include: Top, Bottom, and Center. The default is **Top**.

Syntax `<VerticalJustification>value</VerticalJustification>`

Example `<VerticalJustification>Bottom</VerticalJustification>`

Vertically justifies the text at the bottom of the field.

Defining the HorizontalJustification Tag (Optional)

The HorizontalJustification tag describes how text fits horizontally in the field.

Valid values include: Left, Right, and Center. The default is **Left**.

Syntax <HorizontalJustification>value</HorizontalJustification>

Example <HorizontalJustification>Right</HorizontalJustification>

Horizontally aligns the text on the right side of the field.

DEFINING BAR CODE OPTIONS

This chapter defines the unique set of bar code options for each bar code. Bar codes are separated into one-dimensional and two-dimensional categories.

1D Bar Codes	2D Bar Codes
Codabar	Data Matrix
Code 16K	GS1 DataBar
Code 39	MaxiCode
Code 93	Micro PDF417
Code 128	PDF417
Interleaved 2of5	POSTNET
MSI	Quick Response
UPCA, UPCE, EAN	

Scannable Bar Codes vs. Printable Bar Codes

Use the following table to see which bar codes the printer can scan and print:

Bar Code	Scan	Print	Bar Code	Scan	Print
Codabar	√	√	I2of5	√	√
Code 16		√	I2 of 5 with Barrier Bar	√	√
Code 39 (no check digit)	√	√	MaxiCode	√*	√
Code 39 (MOD 43 check digit)	√	√	MicroPDF417	√*	√
Code 93	√	√	MSI	√	√
Code 128	√	√	PDF417	√*	√
Data Matrix	√*	√	Postnet		√
EAN 8	√	√	Quick Response	√*	√
EAN 8 +2	√	√	UPCA	√	√
EAN 8 +5	√	√	UPCA +2	√	√
EAN 13	√	√	UPCA +5	√	√
EAN 13 +2	√	√	UPCA & Price CD	√	√
EAN 13 +5	√	√	UPCE	√	√
EAN 13 & Price CD	√	√	UPCE +2	√	√
GS1 DataBar/ RSS	√*	√	UPCE +5	√	√

* Requires the 6057 optional 2D scanner; the 2D scanner is standard on the 6140.

The bar code options include, but are not limited to:

- ◆ Human readable
- ◆ Density
- ◆ Characters per inch
- ◆ Narrow width
- ◆ Wide width
- ◆ Narrow space/ wide space.

The *<Options>* tag defines any options supported by the bar code's type. See the following sections to define the Options tag, based on your bar code type.

Defining the Codabar Options Tag (Optional)

Use the Options tag to define Codabar-specific information.

Valid values include: a 32-bit unsigned decimal number.

It contains the following attributes: *density*, *narrowbar*, *widebar*, *narrow space*, *wide space*, and *interchgap*.

Syntax `<Options density="value" narrowbar="value" widebar="value" narrow space="value" wide space="value" interchgap="value" />`

density Bar code density. Options: 2 to 9 as shown below.
The default is **8**.

Density Selector	Density (% or cpi)	Narrow Element Width in Dots/Mils	Narrow to Wide Ratio
2	2.1	8 / 39.4	1:3.0
3	3.0	6 / 29.6	1:2.5
4	4.6	4 / 19.7	1:2.5
5	5.1	4 / 19.7	1:2.0
7	8.4	2 / 9.9	1:3.0
8	9.2	2 / 9.9	1:2.5
9	10.1	2 / 9.9	1:2.0

narrowbar Use the density table above. Using a non-standard value may produce unreadable bar codes. Define in Pixels.
widebar
narrow space
wide space

interchgap The inter character gap between two character representations. This is usually defined the same as *narrow space*. Define in Pixels.

Example `<Options density="4" interchgap="1" />`

Creates a Codabar bar code with a density of **4** and an intercharacter gap of 1.

Defining the Code 16K Options Tag (Optional)

Use the Options tag to define Code 16K-specific information.

Valid values include: a 32-bit unsigned decimal number.

It contains the following attributes: *density* and *subbarheight*.

Syntax `<Options density="value" subbarheight="value" />`

density Bar code density. Options: 4, 6, 8, or 20 as shown below. The default is 8.

Density Selector	Density (% or cpi)	Narrow Element Width in Dots/mils
20	3.5/7.0	5/24.6
4	4.4/8.7	4/19.7
6	5.8/11.7	3/14.8
8	8.7/17.5	2/9.9

subbarheight The height of each row of bars. Define in Pixels.

Example `<Options density="6" />`

Creates a Code 16K bar code with a density of 6 and does not specify a *subbarheight*.

Defining the Code 39 Options Tag (Optional)

Use the Options tag to define Code 39-specific information.

Valid values include: a 32-bit unsigned decimal number.

It contains the following attributes: *density*, *narrowbar*, *widebar*, *narrow space*, *wide space*, *interchargap*, and *mod43cd*.

Syntax `<Options density="value" narrowbar="value" widebar="value" narrow space="value" wide space="value" interchargap="value" mod43cd="value" />`

density Bar code density. Options: 1 to 7, 11, 12, and 20 shown below. The default is 7.

Density Selector	Density (% or cpi)	Narrow Element Width in Dots/Mils	Narrow to Wide Ratio
1	1.4	10 / 49.3	1:2.5
2	1.7	8 / 39.4	1:2.5
3	3.5	4 / 19.7	1:2.5
4	4.2	3 / 14.8	1:3.0
6	6.3	2 / 9.9	1:3.0
7	7.0	2 / 9.9	1:2.5
11	3.9	4 / 19.7	1:2.0
12	12.7	1 / 4.9	1:2.0
20	3.0	5 / 24.6	1:2.2

narrowbar Use the density table above. Using a non-standard value may produce unreadable bar codes. Define in Pixels.
widebar
narrow space
wide space

interchargap The inter character gap between two character representations. This is usually defined the same as *narrow space*. Define in Pixels.

mod43cd Enable Mod43 check digit? Options:
0 Disable
1 Enable (Extended Code 39)

Example `<Options density="6" mod43cd="1" />`

Creates a Code 39 bar code with a density of 6 and the bar code prints as an Extended Code 39 bar code.

Defining the Code 93 Options Tag (Optional)

Use the Options tag to define Code 93-specific information.

Valid values include: a 32-bit unsigned decimal number.

It contains the following attributes: density and narrowbar.

Syntax <Options density="value" and narrowbar="value" />

density Bar code density. Options: 3, 4, 5, 7, and 10 as shown below. The default is 7

Density Selector	Density (% or cpi)	Narrow Element Width in Dots/Mils
3	3.7	6 / 29.6
4	4.5	5 / 24.6
5	5.6	4 / 19.7
7	7.5	3 / 14.8
10	11.2	2 / 9.9

narrowbar Use the density table above. Using a non-standard value may produce unreadable bar codes. Define in Pixels.

Example <Options density="5" />

Creates a Code 93 bar code with a density of 5 and does not specify a narrow bar value.

Defining the Code 128 Options Tag (Optional)

Use the Options tag to define Code 128-specific information.

Valid values include: a 32-bit unsigned decimal number.

It contains the following attributes: density and narrowbar.

Syntax <Options density="value" and narrowbar="value" />

density Bar code density. Options: 4, 6, 8, and 20 as shown below. The default is 8.

Density Selector	Density (% or cpi)	Narrow Element Width in Dots/mils
20	3.5/7.0	5/24.6
4	4.4/8.7	4/19.7
6	5.8/11.7	3/14.8
8	8.7/17.5	2/9.9

narrowbar Use the density table above. Using a non-standard value may produce unreadable bar codes. Define in Pixels.

Example <Options density="6" />

Creates a Code 128 bar code with a density of 6 and does not specify a narrow bar value.

Defining the Interleaved 2of5 Options Tag (Optional)

Use the Options tag to define Interleaved 2of5-specific information.

Valid values include: a 32-bit unsigned decimal number.

It contains the following attributes: *density*, *narrowbar*, *widebar*, and *barrierbar*.

Syntax `<Options density="value" narrowbar="value" widebar="value" barrierbar="value" />`

density Bar code density. Options: 1 to 13 as shown below.
The default is **12**.

Density Selector	Density (% or cpi)	Narrow Element Width in Dots/Mils	Narrow to Wide Ratio
1	1.1	21 / 103.4	1:3.0
2	2.1	12 / 59.1	1:2.5
3	3.2	7 / 34.5	1:3.0
4	4.2	6 / 29.6	1:2.5
5	5.6	4 / 19.7	1:3.0
6	6.3	4 / 19.7	1:2.5
7	7.5	3 / 14.8	1:3.0
8	8.8	3 / 14.8	1:2.3
9	9.6	3 / 14.8	1:2.0
10	11.2	2 / 9.9	1:3.0
11	11.0	2 / 9.9	1:3.0
12	12.7	2 / 9.9	1:2.5
13	14.5	2 / 9.9	1:2.0

narrowbar Use the density table above. Using a non-standard value
widebar may produce unreadable bar codes. Define in Pixels.

barrierbar Print a barrier bar (border lines at the top and bottom of the bar
code). The default is disabled (does not print a barrier bar).
Options:
0 Disable
1 Enable (print a barrier bar)

Example `<Options density="8" barrierbar="1" />`

Creates an I 2of5 bar code with a density of 8 and prints a barrier bar.

Defining the MSI Options Tag (Optional)

Use the Options tag to define MSI-specific information.

Valid values include: a 32-bit unsigned decimal number.

It contains the following attributes: *density*, *narrowbar*, and *widebar*.

Syntax <Options *density*="value" *narrowbar*="value" *widebar*="value" />

density Bar code density. Options: 4, 5, or 7 as shown below.
The default is 7.

Density Selector	Density (% or cpi)	Narrow Element Width in Dots/Mils	Narrow to Wide Ratio
4	4.2	4 / 19.7	1:2.0
5	5.6	3 / 14.8	1:2.0
7	7.2	2 / 9.9 (Default value)	1:2.5

narrowbar Use the density table above. Using a non-standard value
widebar may produce unreadable bar codes. Define in Pixels.

Example <Options *density*="4" />

Creates an MSI bar code with a density of 4 and does not specify a narrow or wide bar value.

Defining the UPCA/UPCE/EAN Options Tag (Optional)

Use the Options tag to define UPCA/UPCE/EAN-specific information. Applies to UPCA +2/+5 Price CD, UPCE +2/+5, EAN8 +2/+5, EAN13 +2/+5 Price CD bar codes.

Valid values include: a 32-bit unsigned decimal number.

It contains the following attributes: *density* and *humanreadable*.

Syntax <Options *density*="value" and *humanreadable*="value" />

density Bar code density. Options: 2 or 4 as shown below.
The default is 2.

Density Selector	Density (% or cpi)	Narrow Element Width in Dots/mils
2	76%	2 / 9.9
4	114%	3 / 14.8

humanreadable Appearance of human readable text with the bar code. The default is 0. Options:

- 0 No human readable text, print bar code only.
- 1 Print data, number system, and check digit.
- 2 Print data only.
- 3 Print data and the number system.
- 4 Print data and check digit.

Example <Options *density*="4" *humanreadable*="4"/>

Creates a UPCA bar code with a density of 4 (114%) and prints data and the check digit along with the bar code.

Defining the Data Matrix Options Tag (Optional)

Use the Options tag to define Data Matrix-specific information.

Valid values include: a 32-bit unsigned decimal number.

It contains the following attribute: density.

Syntax <Options density="value" />

density Bar code density. Options: 0 to 24 as shown below.
The default is 0.

Density Selector	Size Row x Column
0	bar code size is automatically determined by the data.
1	10 x 10
2	12 x 12
3	14 x 14
4	16 x 16
5	18 x 18
6	20 x 20
7	22 x 22
8	24 x 24
9	26 x 26
10	32 x 32
11	36 x 36
12	40 x 40
13	44 x 44
14	48 x 48
15	52 x 52
16	64 x 64
17	72 x 72
18	80 x 80
19	88 x 88
20	96 x 96
21	104 x 104
22	120 x 120
23	132 x 132
24	144 x 144

Example <Options density="4" />

Creates a Data Matrix bar code with a size of 14 rows by 14 columns.

Defining the GS1 DataBar Options Tag (Optional)

Use the Options tag to define GS1 DataBar-specific information.

Valid values include: a 32-bit unsigned decimal number.

It contains the following attributes: *density*, *symboltype*, *sepheight*, and *segmentwidth*.

Note: To print a composite component with any GS1 DataBar bar code, separate the data with the | (split vertical bar). When using a composite component, the *segmentwidth* minimum is 4.

Function 1 is included at the beginning of *symboltype*="6" (GS1 DataBar Expanded).

Syntax <Options *density*="value" *symboltype*="value" *sepheight*="value"
segmentwidth="value" />

density Bar code density. Options: 2 to 8 as shown below.
The default is **2**.

Density Selector	Narrow Element Width in Dots/mils
2	2 / 9.9
3	3 / 14.8
4	4 / 19.7
5	5 / 24.6
6	6 / 29.6
7	7 / 34.5
8	8 / 39.4

symboltype Selects the type of GS1 DataBar bar code. The default is **1**.
Options:

- 1 GS1 DataBar 14
- 2 GS1 DataBar 14 Truncated
- 3 GS1 DataBar 14 Stacked
- 4 GS1 DataBar 14 Stacked Omni-directional
- 5 GS1 DataBar Limited
- 6 GS1 DataBar Expanded
- 7 UPCA
- 8 UPCE
- 9 EAN13
- 10 EAN8
- 11 UCC/EAN128 and CC A/B
- 12 UCC/EAN128 and CC C

sepheight The height of the separator between the linear barcode and the 2D bar code. The default is **1**. The value is either 1 or 2.

segmentwidth The width of the individual segments for bar code <types> 1 to 6 above. The default is **22**. The range is even numbers between 2 and 22. When using a composite component, the *segmentwidth* minimum is 4.

Example <Options *density*="4" *symboltype*="3" *segmentwidth*="8" />

Creates a GS1 DataBar 14 Stacked bar code with a density of 4 and sets the segment width to 8.

Example `<BarcodeField id="GS1EXPANDED">`
 `<Volatile>1</Volatile>`
 `<Origin units="Inches" x="0.10" y="0.55" justification="Left" />`
 `<BarHeight units="Inches">0.40</BarHeight>`
 `<Type>gs1</Type>`
 `<Options density="2" symboltype="6" segmentwidth="4"/>`
 `<Data>01937123456789043103001234|911A2B3C4D5E</Data>`
 `</BarcodeField>`

Creates a GS1 DataBar Expanded bar code with a density of 2 and sets the segment width to 4. The data includes the composite component separated by | (split vertical bar).

Defining the MaxiCode Options Tag (Optional)

Use the Options tag to define MaxiCode-specific information.

Valid values include: a 32-bit unsigned decimal number.

It contains the following attribute: mode.

Syntax `<Options mode="value" />`

mode Select the MaxiCode mode. The default is **8**. Options:

Mode	Name	Description
0	Obsolete	Superseded by modes 2 and 3.
2	Structured Carrier Message	Structured shipping data, with a numeric postal code.
3	Structured Carrier Message	Structured shipping data, with a numeric postal code.
4	Standard	Standard text mode.
5	Full EEC	Standard text mode with enhanced error correction.
6	Reader Program	Data is designed to program the scanner/barcode reader.
8	Auto-detect	Auto-detect between modes 0, 2, and 3.

To enter data for Modes 2 or 3, use the `<Data>` tag.

Defining the Data Tag (Required)

The Data tag contains the data for MaxiCode Mode 2 or Mode 3 bar codes.

Valid values include: Any Unicode string less than 2K characters.

It contains the following attributes: Year, PostalCode, CountryCode, ServiceClass, TrackingNumber, OriginCarrier, ShipperNumber, DayOfPickup, ShipmentID, PackageCount, Weight, AddressValidation, StreetAddress, City, and State.

Note: These attributes are case sensitive.

Syntax `<Data Year="value" PostalCode="value" CountryCode="value" ServiceClass="value" TrackingNumber="value" OriginCarrier="value" ShipperNumber="value" DayOfPickup="value" ShipmentID="value" PackageCount="value" Weight="value" AddressValidation="value" StreetAddress="value" City="value" State="value" />`

<i>Year</i>	Two digit year identifier. The default is 11.
<i>PostalCode</i>	Zip or postal code, maximum of nine characters. If this field is numeric, use Mode 2; otherwise, use Mode 3. The default is " ".
<i>CountryCode</i>	Three digit ISO country code. The default is " ".
<i>ServiceClass</i>	Three digit class of service code. The default is " ".
<i>TrackingNumber</i>	Package tracking number. The default is " ".
<i>OriginCarrier</i>	Origin carrier SCAC. The default is " ".
<i>ShipperNumber</i>	UPS shipper number. The default is " ".
<i>DayOfPickup</i>	Julian day of pickup. The default is " ".
<i>ShipmentID</i>	The shipment identifier. The default is " ".
<i>PackageCount</i>	The count and identifier of this package in this format: 1/1, 2/5, etc. The default is " ".
<i>Weight</i>	Package weight. The default is " ".
<i>AddressValidation</i>	Perform address validation? The default is " ". Options: Y Yes N No
<i>StreetAddress</i>	Street address. The default is " ".
<i>City</i>	City name. The default is " ".
<i>State</i>	Two character state identifier. The default is " ".

Example `<Options mode="2" />
<Data PostalCode="068100000" CountryCode="840" ServiceClass="001"
TrackingNumber="1Z12345675" OriginCarrier="UPSN" ShipperNumber="12345E"
DayOfPickup="089" ShipmentID="" PackageCount="1/1" Weight="10"
AddressValidation="Y" State="CT" />`

Creates a MaxiCode Mode 2 bar code.

Additionally, MPCLII (Monarch® Printer Control Language) batch data for a MaxiCode bar code can be included in the <Data> tag. Sample MPCLII MaxiCode batch data is shown below:

```
1,"[]>~030" |
C,"01~02996" |
C,"068100000~029" |
C,"840~029" |
C,"001~029" |
C,"1Z12345675~029" |
C,"UPSN~029" |
C,"12345E~029" |
C,"089~029" |
C,"~029" |
C,"1/1~029" |
C,"10~029" |
C,"Y~029" |
C,"~029" |
C,"~029" |
C,"CT~030" |
C,"~004" | }
```

The LNT file with the <Data> tag is shown below:

```
Example <Data>"[]>~03001~02996068100000~029840~029001~0291Z12345675
~029UPSN~02912345E~029089~029~0291/1~02910~029Y~029~029~029CT~ 030~004"
</Data>
```

Note: MPCLII continuation fields are not used in LNT.

Defining the Micro PDF417 Options Tag (Optional)

Use the Options tag to define Micro PDF417-specific information.

Valid values include: a 32-bit unsigned decimal number.

It contains the following attributes: density, rows, and columns.

Syntax <Options density="value" rows="value" columns="value" />

density Bar code density. If a density is not selected, the default is set to the smallest size that fits the data. Options: 1 to 9 as shown below.

Density Selector	Element Width in Dots/Mils	Row Height in Dots/Mils	Aspect Ratio
1	2 / 9.8	2 / 9.8	1:1
2	2 / 9.8	4 / 19.7	1:2
3	2 / 9.8	6 / 29.6	1:3
4	3 / 14.8	3 / 14.8	1:1
5	3 / 14.8	6 / 29.6	1:2
6	3 / 14.8	9 / 44.3	1:3
7	4 / 19.7	4 / 19.7	1:1
8	4 / 19.7	8 / 39.4	1:2
9	4 / 19.7	12 / 59.1	1:3

rows The number of rows can be set to change the shape of the bar code.

columns The number of columns can be set to change the shape of the bar code.

Example <Options density="3" rows="5" columns="6" />

Creates a Micro PDF417 bar code using a density of 3, sets the number of rows to 5 and the number of columns to 6.

Defining the PDF417 Options Tag (Optional)

Use the Options tag to define PDF417-specific information.

Valid values include: a 32-bit unsigned decimal number.

It contains the following attributes: *density*, *security*, *compact*, *rows*, and *columns*.

Syntax `<Options density="value" security="value" compact="value" rows="value" columns="value" />`

density Bar code density. If a density is not selected, the default is set to the smallest size that fits the data. Options: 1 to 9 as shown below.

Density Selector	Element Width in Dots/Mils	Row Height in Dots/Mils	Aspect Ratio
1	2 / 9.8	2 / 9.8	1:1
2	2 / 9.8	4 / 19.7	1:2
3	2 / 9.8	6 / 29.6	1:3
4	3 / 14.8	3 / 14.8	1:1
5	3 / 14.8	6 / 29.6	1:2
6	3 / 14.8	9 / 44.3	1:3
7	4 / 19.7	4 / 19.7	1:1
8	4 / 19.7	8 / 39.4	1:2
9	4 / 19.7	12 / 59.1	1:3

security Sets the security level of the bar code. Higher security levels add data to a bar code, improving scan reliability. Some damaged bar codes may still be scannable if the security level is high enough. Options: 0 to 8. The default is **0**.

compact Print the bar code in Compact mode. Compact mode omits the right line number codeword and reduces the stop pattern to a single bar. Options:
0 Prints in standard mode.
1 Prints in Compact mode.

rows The number of rows can be set to change the shape of the bar code.

columns The number of columns can be set to change the shape of the bar code.

Example `<Options density="3" security="4" />`

Creates a PDF417 bar code using a density of 3 and a security level of 4.

Defining Data for POSTNET (Optional)

The Data tag contains the data for the POSTNET bar code.

Valid values include: Any Unicode string less than 2K characters.

Syntax <Data>"string"</Data>

Density Selector	Density (% or cpi)	Narrow Element Width in Dots/Mils	Narrow to Wide Ratio	Data Length
0 (fixed at 4.3 cpi)	24/118.2	10/49.3	4/19.7 (5 dot gap)	0, 5, 6, 9, 10, 11 or 12

Example <Data>"28028"</Data>

Prints the data 28028 in a POSTNET bar code.

Defining the Quick Response Options Tag (Optional)

Use the Options tag to define Quick Response-specific information. The Quick Response bar code is identified by either *qr* or *quickresponse*.

Quick Response (QR Code) is a two-dimensional bar code, which is made up of square modules arranged in an overall square pattern. A unique finder pattern is located at three corners of the symbol. Four levels of error correction are available, along with a wide range of symbol sizes.

- ◆ Model 1 is the original specification.
- ◆ Model 2 is an enhanced form that includes additional features.

The maximum number of characters depends on the type of characters entered for the batch data and differs for the two models of QR Code.

QR Code can accommodate Japanese Kana and Kanji characters and has a variety of applications, including marking spark plugs, radiators, printed circuit boards, and test tubes. Refer to the *AIM International Symbology Specification* for more details about data requirements.

Since the QR code may contain various types of data, specify your data using the *datamode* attribute.

Valid values include: a 32-bit unsigned decimal number.

It contains the following attributes: *model*, *mpclstyle*, *security*, *datamode*, *barcodemode*, *paritybyte*, *codenumber*, and *codecount*.

Syntax <Options *model*="value" *mpclstyle*="value" *security*="value" *datamode*="value" *barcodemode*="value" *paritybyte*="value" *codenumber*="value" *codecount*="value" />

model Bar code models. The default is **2**. There are two models: 1 and 2.

mpclstyle Use the *mpclstyle* to define this bar code. The default is **0**. Options:

0 Use XML to define the bar code.

1 Use the *mpclstyle* to define the bar code. See "[Using MPCLSTYLE for the Quick Response Bar Code](#)" for more information.

<i>security</i>	Sets the error correction level for the bar code. The default is 2 . Options: 1 High Density Level 2 Standard Level 3 High Reliability Level 4 Ultra High Reliability Level
Note:	As you increase the error correction level, the maximum number of characters (in the bar code) decreases.
<i>datamode</i>	Describes the type of data entered in the bar code. The default is 1 . Options: 1 Automatic Mode Detection 2 Manual, Alphanumeric Mode 3 Manual, Binary Mode 4 Manual, Kanji Mode 5 Manual, Numeric Mode
Note:	If using numeric mode, a leading zero will be removed/suppressed.
<i>barcodemode</i>	Describes the bar code's mode. The default is 1 . There are two modes: 1 (Standard mode) or 2 (Structured Append Mode).
<i>paritybyte</i>	Parity byte. Use only for Structured Append Mode. Use a two-digit number in hexadecimal. There is no standard parity byte. The default is 1 . Range: 1 to 255.
<i>codenumber</i>	Use only for Structured Append Mode. The code number of the individual symbol in the concatenated set. Use a two-digit number in decimal. The default is 0 . The range is 0 to 255.
<i>codecount</i>	Use only for Structured Append Mode. The total number of symbols in the concatenated set. Use a two-digit number in decimal. The default is 0 . The range is 0 to 255.

Example `<BarcodeField id="qr">`

`<Data min="1" max="16"/>`

`<Volatile>0</Volatile>`

`<Origin units="Inches" justification="Left" x="0.0" y="0.4"/>`

`<BarHeight units="Inches">0.6</BarHeight>`

`<Type>quick response</Type>`

`<Options model="2" mpclstyle="0" security="2" datamode="1" barcodemode="1"/>`

`</BarcodeField>`

Creates a Quick Response bar code using model 2, defines the bar code using XML, sets the error correction level to standard reliability, uses the automatic data detection mode and the standard mode of QR.

Example `<Options model="2" humanreadable="2" mpclstyle="0" security="3" datamode="2"/>`

`<Data>"https://printers.averydennison.com"</Data>`

Creates a Quick Response bar code using model 2, defines the bar code using XML, sets the error correction level to high reliability, and uses alphanumeric data.

Using MPCLSTYLE for the Quick Response Bar Code

To use the MPCLII (Monarch® Printer Control Language) style for the Quick Response bar code, set *mpclstyle* to 1. Then, use the *<Data>* tag to contain the Quick Response bar code data.

Defining the Data Tag (Required)

Valid values include: Any Unicode string less than 2K characters.

Syntax *<Data>"string"</Data>*

For example, the MPCLII (Monarch® Printer Control Language) batch data for a QR code is shown below:

```
1,"HM,N0123456789012345" | }
```

This QR code uses the ultra high reliability level of error correction with numeric data interpretation.

The LNT style with the *<Data>* tag is shown below:

```
Example     <BarcodeField id="quickresponse">  
              <Options mpclstyle="1"/>  
              <Data>"HM,N0123456789012345"</Data>
```

This QR code uses the MPCL style with an error correction level of ultra high reliability, uses manual detection mode and numeric data.

```
Example     <Options mpclstyle="1"/>  
              <Data>"MA,https://printers.averydennison.com"</Data>
```

This QR code sets the error correction level to standard reliability, uses the automatic data detection mode and includes an embedded URL in the bar code data.

Job data defines the data printed in each field on the supply. You can also specify printer configuration information to override any values set in the Job Packet.

Field data is applied in numeric order or by the optional *id*. Each job data file must use the same method for each field on the supply. If data is supplied for two fields by the optional *id*, the remaining fields on the supply must also have data supplied by the optional *id*.

JobData packets are not necessary for most applications. Standard print and apply applications use the device API to issue print commands directly to the system. JobData packets provide a file-based mechanism that may prove useful in print server-style applications. You can test JobData packet functionality by putting the packet into a file with a .job extension and moving that file into the Print hot folder.

Defining the JobData Container (Required)

The JobData tag is a container for the list of all fields (label layout) in the LNT file. There must be one of these per job.

It contains the following attributes: *id* and *count*.

Syntax `<JobData id="value" count="value">`
 job data information
 `</JobData>`

id The identifier (name) of the target LNT. Any applications using LNT should reference this data. Use any 32-character maximum (UNICODE) string. Do not use the same name for two files or an error occurs!

count The number of fields in this file. If it is not defined, the count is automatically calculated.

Example `<JobData id="SaleText" count="2">`
 job data information
 `</Fields>`

Specifies data for SaleText, which contains two fields.

Defining the Field Container (Optional)

The Fields tag is a container for one field's data.

Valid values include: Any UNICODE string containing less than 256 characters.

It contains the following attribute: *id*.

Syntax `<Field id="value">Data</Field>`

id The identifier (name) of the target <Field>. All Fields in a <JobData> file should have this attribute or none of the fields should have it defined. If all <Field>s have an *id* defined, the data is used in the named fields. If all <Field>s do not have an *id* defined, the data is used in the order it is received.

Example `<Field id="Price">$19.99</Field>`

Defines \$19.99 as the data for the Price <Field>.

Defining Printer Setup XML Tags

These Printer Setup tags can be defined in the `<JobData>` file for a single print job. Printer settings in the `<JobData>` file take priority over these settings defined in the LNT file.

Defining the Quantity Tag (Optional)

The Quantity tag specifies the number of labels to print.

Valid values include: 1 to 999. The default is 1.

Syntax `<Quantity>value</Quantity>`

Example `<Quantity>5</Quantity>`

Prints 5 copies of label.

Defining the Energy Tag (Optional)

The Energy tag defines the printhead energy level. The Energy tag defines the printhead energy level. You may need to adjust this value depending on the type of supplies you are using. For example, synthetic supplies require the High energy setting, but standard paper does not.

Syntax `<Energy>value</Energy>`

value Energy Value. Options:
 Normal Use for standard paper. This is the default.
 High Use for synthetic supplies.

Example `<Energy>High</Energy>`

Sets the printhead energy to high for synthetic supplies.

Defining the Contrast Tag (Optional)

The Contrast tag defines the print contrast for the job. You may need to adjust this value depending on the type of supplies you are using. For example, synthetic supplies require a higher print contrast, but standard paper requires less contrast.

Note: Solid black print should not exceed 30% on a given square inch of the label, or the printhead life may be decreased.

Syntax `<Contrast>value</Contrast>`

value Contrast percentage. Do not include the percent sign.
 The range is -100% (minimum contrast) to 100% (maximum contrast). The default is 0 (no contrast adjustment)

Example `<Contrast>35</Contrast>`

Sets the print contrast to 35% for this job.

Defining the PrintSpeed Tag (Optional)

The PrintSpeed tag defines the print speed in inches per second (ips) for the job.

Valid values include: 1.0, 1.5, 2.0, 3.0, 4.0, or 5.0.

It contains the following attribute: fixed

Serial bar codes, lines, and graphics print at 2.0 ips. Synthetic supplies and special supplies print at 1.5 ips.

Syntax <PrintSpeed fixed="value">value</PrintSpeed>

Fixed The printer prints at the specified setting until the battery drains.
Options:

0 False (default)
1 True

The Fixed value can be set to 3.0, 4.0 or 5.0 inches per second printing. However, fixed is only recommended for text formats, where print speed is required over print quality.

Example <PrintSpeed fixed="1">5.0</PrintSpeed>

Sets the printer's speed to 5.0 ips, but allows the speed to vary from 5.0 ips for serial bar codes, etc.

Defining the UseBlackMark Tag (Optional)

The UseBlackMark tag specifies if the printer uses the black mark sensor to sense supplies.

Valid values include: 0 (off) and 1 (on). The default is 1.

Syntax <UseBlackMark>value</UseBlackMark>

value Use Black Mark Value. Options:
0 Off. Do not use black mark sensor.
1 ON. Use the black mark sensor. This is the default.

Example <UseBlackMark>1</UseBlackMark>

The printer uses the black mark sensor to calibrate and feed labels.

Defining the UseOnDemand Tag (Optional)

The UseOnDemand tag specifies if the printer uses the on-demand sensor to sense supplies.

Printer	On-Demand Sensor
6057	<i>optional</i>
6059	standard
6140	not available

Syntax <UseOnDemand>value</UseOnDemand>

value Use On-demand Sensor Value. Options:
0 Off. Do not use on-demand sensor. This is the default.
1 ON. Use the on-demand sensor.

Example <UseOnDemand>0</UseOnDemand>

The printer does not use the on-demand sensor.

Defining the SensorMode Tag (Optional)

The SensorMode tag specifies which sensor to use, based on your supply type.

Valid values include: "DieCut" and "BlackMark". The default is "DieCut".

Syntax <UseSensorMode>value</UseSensorMode>

value

Sensor Mode Value. Options:

DieCut Use the on-demand sensor. This is the default.

BlackMark Use the black mark sensor.

Example <UseSensorMode>"DieCut"</UseSensorMode>

The printer uses the die cut sensor.

Sample JobData File

The following sample

- ◆ creates job data for the **DailySpecials** LNT file.
- ◆ defines unique printer setup information (print contrast, speed, etc.) *only* for this print job.
- ◆ uses \$19.99 as the data for the **PRICE** field and Red Wool Sweater as the data for the **DESC** field.

```
<JobData id="DailySpecials" count="2">  
  <Quantity>1</Quantity>  
  <Energy>Normal</Energy>  
  <Contrast>0</Contrast>  
  <PrintSpeed fixed="0">4</PrintSpeed>  
  <UseBlackMark>1</UseBlackMark>  
  <UseOnDemand>0</UseOnDemand>  
  <Field id="PRICE">$19.99</Field>  
  <Field id="DESC">Red Wool Sweater</Field>  
</JobData>
```

ERROR MESSAGES

6

This chapter provides explanations of your printer's errors. The errors are listed in order. If you have trouble loading supplies or performing maintenance, refer to the *Operator's Handbook* or *Equipment Manual*. Call Technical Support if you receive any error message not listed in this chapter.

Error Code	Description
5	Label Size Image width is invalid. See " Defining the LabelSize Tag (Required) " for more information.
12	Image Size Height is invalid. See " Defining the ImageSize Tag (Required) " for more information.
13	Image Size Width is invalid. See " Defining the ImageSize Tag (Required) " for more information.
18	More data provided than amount specified in <data min max> tag. See " Defining the Data Tag " for more information.
21	Horizontal justification is invalid. See " Defining the HorizontalJustification Tag " for more information.
31	Human readable font selection is invalid. See " Defining the UPCA/UPCE/EAN " for more information.
32	Bar code type is invalid. See " Defining the Type Tag " for more information.
33	Bar code density is invalid. See Chapter 4, " Defining Bar Code Options " for more information.
102	The print quantity is invalid. See " Defining the Quantity Tag (Optional) " for more information.
106	The print multiple is invalid.
210	Bar code security level is invalid. See Chapter 4, " Defining Bar Code Options " for more information.
213	PDF417 data is invalid. See Chapter 4, " Defining Bar Code Options " for more information.
223	Bar code option is invalid. See Chapter 4, " Defining Bar Code Options " for more information.
255	Supply type is invalid.
256	Energy setting is invalid. See " Defining the Energy Tag (Optional) " for more information.
257	Feed mode is invalid.
258	Supply position is invalid.
259	Contrast is invalid.
260	Print Adjustment is invalid.
261	Margin Adjustment is invalid.
262	Speed Adjustment is invalid.
287	Printhead Width specification is out of range.
288	Printer voltage is out of range.

- 290 Backfeed action is invalid.
- 291 Backfeed position is invalid.
- 292 Backfeed distance is invalid.
- 380 Job request is invalid.
- 381 The 6140 printer cannot connect to the smart device. The maximum number of 6140 printers that can connect via Bluetooth to one smart device is 7.
- 401 Internal software failure.
- 409 The printer's memory is full.
- 428 Invalid Batch or Graphic.
- 574 Check digit could not generate.
- 601 Failed to image.
- 614 The field is positioned off the label. This error is only reported when enabled. See ["Enabling the 'Field Off Tag' Warning"](#) for more information.
- 615 PDF417 mode is invalid.
- 616 The printhead has too many bad dots to print.
- 680 Sound not found. The requested sound was not found on the 6140. Refer to the PlaySound method in the *SDK documentation*.
- 681 Sound queue full. The requested sound cannot be played because the sound queue is full. Refer to the PlaySound method in the *SDK documentation*.
- 682 The sound replay count is invalid. The range is 1 to 8. Refer to the PlaySound method in the *SDK documentation*.
- 703 The printer sensed a calibration of different-sized black marks. Make sure the correct supply is loaded.
- 704 Printer has not sensed a supply mark within the specified number of inches or out of supplies.
- 706 The printer's motor is jammed or encoder error.
- 750 Printhead is overheated. Turn off the printer to let the printhead cool. If the error persists, call Technical Support.
- 751 Printer did not sense a black mark when expected. The supply may be jammed. Reload supply. If the error continues to appear, call Technical Support.
- 752 Printer sensed a black mark in the wrong place.
- 753 Printer sensed a black mark that is too long.
- 755 Printhead is open.
- 756 The printer is out of supplies. Load supplies and/or clean the supply sensor.
- 758 Check supply. Either the supply is not seen, or the on-demand sensor is broken (purchase optional). Check for a label jam. Clear the supply path or reload supplies.
- 762 The printer's battery is low. Charge the battery.
- 765 The printhead has less than 3 bad dots.
- 766 Backfeed/overfeed error. There is a problem with the backfeed or overfeed distance.
- 768 Printhead has more than 8 bad dots or is not connected. Make sure the printhead is connected.

790 The printer is busy. Turn off the printer. Wait two seconds and turn it back on. If the problem continues, call Technical Support.

793 Printer job queue is full.

Hard Printer Errors

Call Technical Support if you receive any error messages greater than 900.

900 Ram test failure.

904 No configuration memory for Native layer.

906 Power failure. Call Technical Support.

907 No configuration memory for Application layer.

909 Configuration memory did not identification check.

910 Warm start.

911 Virgin restart.

930 Error while erasing flash memory.

931 Error while writing flash memory.

932 Error while writing RAM.

940 Flash address is illegal.

1050 Black mark calibration failed. You may need to replace the sensor or motor.

1999 Print Engine crashed and left the status line high.

536873413 Parser Error. Invalid input buffer.

536873414 Parser Error. Invalid output buffer.

536873415 Parser Error. Invalid command.

536873416 Parser Error. Invalid command.

536873417 Parser Error. LNT file is not found.

536873418 Parser Error. Error expanding the packet.

536873419 Parser Error. Field is not found.

536873420 Parser Error. Invalid parser selection.

536873421 Parser Error. Error storing output.

536873422 Parser Error. Font is not found.

536873423 Parser Error. Image is not found.

536873424 Parser Error. Print failed.

536873313 Printer Client Services Error. Invalid input buffer.

536873314 Printer Client Services Error. Invalid output buffer.

536873315 Printer Client Services Error. Invalid command.

536873316 Printer Client Services Error. Invalid command.

536873317 Printer Client Services Error. LNT file is not found.

536873318 Printer Client Services Error. Error expanding packet.

536873319 Printer Client Services Error. Field is not found.

536873320 Printer Client Services Error. Print buffer overrun.

536873669	Invalid MPCL Packet.
536877509	Scanner Error. Invalid command.
536877510	Scanner Error. Invalid option.
536877511	Scanner Error. Configuration failed.
536911873	Resource Manager Error. Error opening database.
536911874	Resource Manager Error. Unable to modify protected resource.
536911875	Resource Manager Error. Alias is not found.
536911876	Resource Manager Error. Application not found.
536911877	Resource Manager Error. Invalid Job.
536911878	Resource Manager Error. Invalid Image.
536911879	Resource Manager Error. Invalid TextField.
536911880	Resource Manager Error. Invalid BarcodeField.
536911881	Resource Manager Error. Invalid LineField.
536911882	Resource Manager Error. Invalid BoxField.
536911883	Resource Manager Error. Invalid EllipseField.
536911884	Resource Manager Error. Invalid GraphicField.
536911885	Resource Manager Error. Invalid XML file.
536911886	Resource Manager Error. Imaging initialization failure.
536911887	Resource Manager Error. Imaging file error.
536911888	Resource Manager Error. Imaging decode error.
536911889	Resource Manager Error. Imaging timeout error.
536911890	Resource Manager Error. Invalid Resource DLL.
536915969	Spooler Error. Command channel return buffer is empty.
536915970	Spooler Error. Command channel return buffer is incorrect.
536915971	Spooler Error. Checksum error.
536915972	Spooler Error. Invalid command or setting provided
536915973	Spooler Error. Invalid command or setting provided
536915974	Spooler Error. Failed to image to the printhead.
536915975	Spooler Error. Overlapped synchronous calls from the same context.
536924161	The XML file is invalid.
536924162	Data included in the field is wrong or misplaced.
536924163	Data included in the field is wrong or misplaced.
536924164	Field name is not recognized.
536924165	Field name is valid, but not in this context.
536924166	One of the field attributes contains invalid data.
536924167	One of the field attributes contains no data.
536924168	One of the field attributes is not recognized.
536924169	One of the field attributes is invalid.

2	File is not found.
6	Invalid handle.
8	Out of memory.
14	Out of memory.
50	Not supported.
87	Invalid parameter.
111	Buffer overrun.
122	Insufficient buffer.
183	The file already exists.

SAMPLE LNT FILES

This appendix contains sample LNT files. Sample LNT files are included in the `\Windows\Resources\LNTs` folder on the 6057 Mobile Device (printer).

Code 39 Bar Code with Text Sample

This sample contains a Code 39 bar code with a text field. The application needs to call this LNT file before the user enters data at print time.

```
<?xml version="1.0" ?>
<Job>
  <Quantity>1</Quantity>
  <LabelSize units="Inches" length="1.10" width="2.00" />
  <Image id="Code39" version="1">
    <ImageSize units="Inches" x="0.05" y="0.00" height="1.00" width="2.00"
origin="BottomLeft" />
    <Fields count="2">
      <BarcodeField id="Code39BC">
        <Volatile>1</Volatile>
        <Origin units="Inches" x="0.80" y="0.17" justification="Center" />
        <BarHeight units="Inches">0.50</BarHeight>
        <Orientation>0</Orientation>
        <Type>code39</Type>
        <Options density="12" />
        <Data max="20" min="0" />
      </BarcodeField>
      <TextField id="Code39HR">
        <Volatile>1</Volatile>
        <BoundingBox units="Inches" x="0.80" y="0.04" height="0.00" width="0.00" />
        <Font pointsizeheight="10.0" pointsizewidth="0" weight="400">Arial Bold</Font>
        <BackgroundColor>Black</BackgroundColor>
        <ForegroundColor>White</ForegroundColor>
        <VerticalJustification>Bottom</VerticalJustification>
        <HorizontalJustification>Center</HorizontalJustification>
        <Data max="20" min="0" />
      </TextField>
    </Fields>
  </Image>
</Job>
```

Fixed Field Sample

This sample defines all fixed fields (two text fields and a UPCA bar code field) and prints immediately when copied into the Mobile Device's (printer's) **Temp\Print** folder.

```
<?xml version="1.0" ?>
<Job>
  <Quantity>1</Quantity>
  <LabelSize units="Inches" length="2.00" width="2.00" />
  <Image id="pretzels" version="1">
    <ImageSize units="Inches" x="0.0" y="0.0" height="2.00" width="2.00" origin="TopLeft" />
    <Fields count="3">
      <TextField id="item">
        <Volatile>0</Volatile>
        <BoundingBox units="Inches" x="0.35" y="0.25" height="0" width="0.75" />
        <Font pointsizeheight="11" pointsizewidth="8" weight="500">Arial</Font>
        <VerticalJustification>Bottom</VerticalJustification>
        <HorizontalJustification>Left</HorizontalJustification>
        <Data>PRETZELS</Data>
      </TextField>
      <BarcodeField id="upca">
        <Volatile>0</Volatile>
        <Origin units="Inches" justification="Left" x="0.400" y="1.050"/>
        <BarHeight units="Inches">0.50</BarHeight>
        <Type>upca</Type>
        <Options density="4" humanreadable="1" />
        <Data>123456789012</Data>
      </BarcodeField>
      <TextField id="price">
        <Volatile>0</Volatile>
        <BoundingBox units="Inches" x="0.70" y="1.35" height="0" width="0" />
        <Font pointsizeheight="11" pointsizewidth="11" weight="600">Arial Bold</Font>
        <VerticalJustification>Bottom</VerticalJustification>
        <HorizontalJustification>Left</HorizontalJustification>
        <Data>$0.79</Data>
      </TextField>
    </Fields>
  </Image>
</Job>
```

Text Field Sample

This sample contains four text fields. The application needs to call this LNT file before the user enters data at print time.

```
<?xml version="1.0" ?>
<Job>
  <UseBlackMark>1</UseBlackMark>
  <PrintSpeed fixed="1">5.0</PrintSpeed>
  <Quantity>1</Quantity>
  <LabelSize units="Inches" length="1.0" width="2.0" />
  <Image id="ScanNPrint" version="1">
    <ImageSize units="Inches" x="0.1" y="0.1" height=".75" width="2" origin="TopLeft"/>
  <Fields count="4">
    <TextField id="TYPE_TEXT">
      <Volatile>0</Volatile>
      <BoundingBox units="Inches" x="0.01" y="0.01"/>
      <DrawMode>Opaque</DrawMode>
      <Font pointsizeheight="7.0" pointsizewidth="6.0" weight="800">Vera Mono</Font>
      <VerticalJustification>Bottom</VerticalJustification>
      <HorizontalJustification>Left</HorizontalJustification>
      <Data max="4" min="0" />
    </TextField>
    <TextField id="TYPE">
      <Volatile>1</Volatile>
      <BoundingBox units="Inches" x="0.1" y="0.14"/>
      <DrawMode>Opaque</DrawMode>
      <Font pointsizeheight="7.0" pointsizewidth="6.0" weight="800">Arial</Font>
      <VerticalJustification>Bottom</VerticalJustification>
      <HorizontalJustification>Left</HorizontalJustification>
      <Data max="20" min="0" />
    </TextField>
    <TextField id="DATA_TEXT">
      <Volatile>0</Volatile>
      <BoundingBox units="Inches" x="0.01" y="0.3"/>
      <DrawMode>Opaque</DrawMode>
      <Font pointsizeheight="7.0" pointsizewidth="6.0" weight="800">Vera Mono</Font>
      <VerticalJustification>Bottom</VerticalJustification>
      <HorizontalJustification>Left</HorizontalJustification>
      <Data max="4" min="0" />
    </TextField>
    <TextField id="DATA">
      <Volatile>1</Volatile>
      <BoundingBox units="Inches" x="0.1" y="0.43"/>
      <DrawMode>Opaque</DrawMode>
      <Font pointsizeheight="7.0" pointsizewidth="6.0" weight="800">Arial</Font>
```

```

    <VerticalJustification>Bottom</VerticalJustification>
    <HorizontalJustification>Left</HorizontalJustification>
    <Data max="20" min="0" />
  </TextField>
</Fields>
</Image>
</Job>

```

International Font Sample

This sample defines two fixed text fields using the MingLiU™ font (trademark by DynaComware Corp.) and prints immediately when copied into the Mobile Device's (printer's) **Temp\Print** folder. You must install the MingLiU font first. ">

```

<?xml version="1.0" ?>
<Job>
  <Quantity>1</Quantity>
  <LabelSize units="Inches" length="1.0" width="2.0" />
  <Image id="FontTest" version="1">
    <ImageSize units="Inches" x="0.1" y="0.1" height=".75" width="2" origin="TopLeft"/>
    <Fields count="2">
      <TextField id="TYPE_TEXT">
        <Volatile>0</Volatile>
        <BoundingBox units="Inches" x="0.01" y="0.01"/>
        <DrawMode>Opaque</DrawMode>
        <Font pointsizeheight="12.0">MingLiu</Font>
        <VerticalJustification>Bottom</VerticalJustification>
        <HorizontalJustification>Left</HorizontalJustification>
        <Data max="4" min="0" > 双字节字体 </Data>
      </TextField>
      <TextField id="DATA_TEXT">
        <Volatile>0</Volatile>
        <BoundingBox units="Inches" x="0.01" y="0.30"/>
        <DrawMode>Opaque</DrawMode>
        <Font pointsizeheight="12.0">MingLiu</Font>
        <VerticalJustification>Bottom</VerticalJustification>
        <HorizontalJustification>Left</HorizontalJustification>
        <Data max="4" min="0" >您好</Data>
      </TextField>
    </Fields>
  </Image>
</Job>

```

Note: Unicode tilde sequences can be used in place of the International characters within the <Data> tag. Depending on your font, <Data>~125~002</Data> produces this character: 紉.

DESIGN TOOLS



Use copies of these worksheet or grids to create label layouts.

Origin (Millimeters)

<ImageSize units="Millimeters" x="1.3" y="0.00000" height="19.000" width="50.800" origin="BottomLeft" />

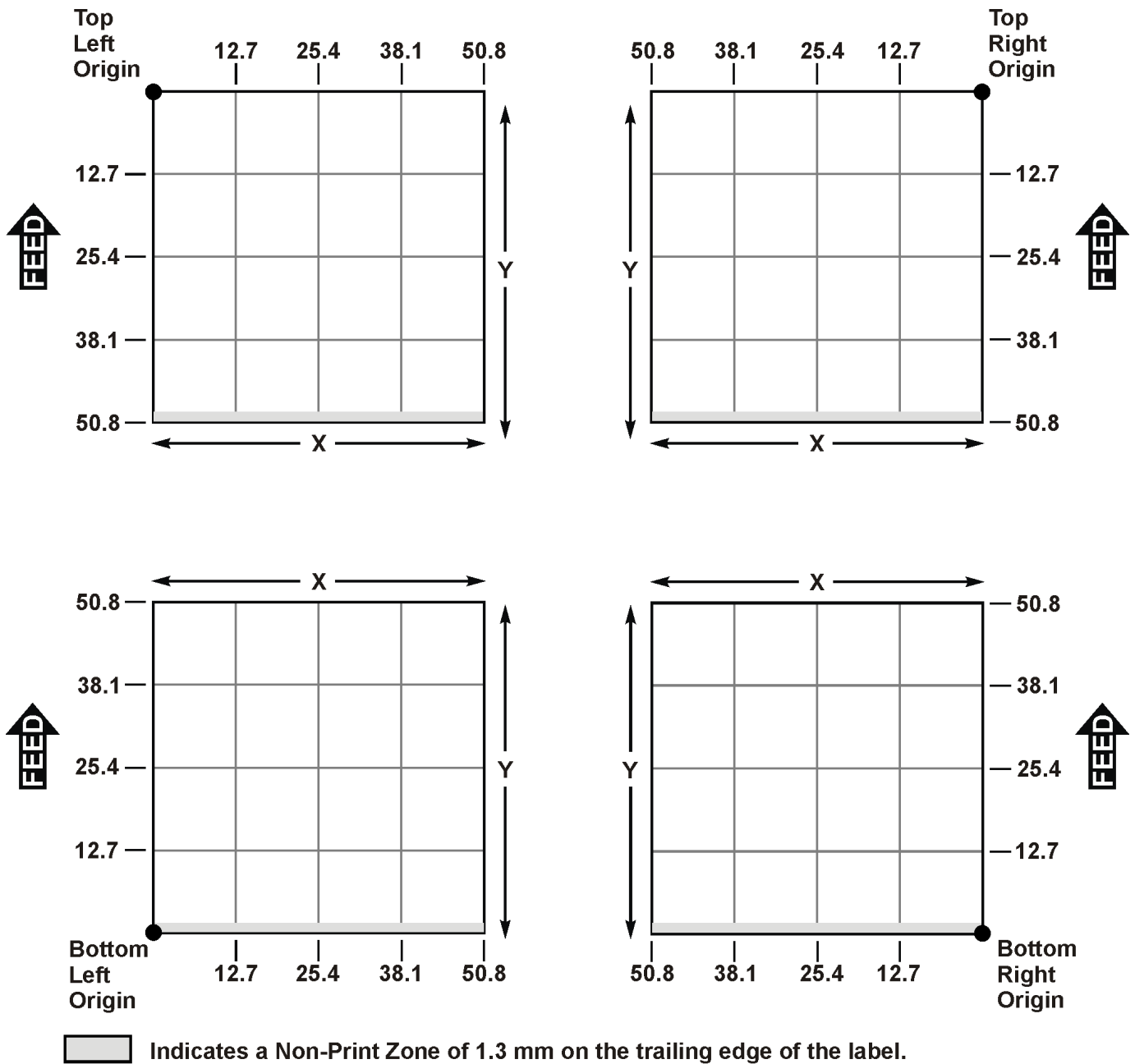

Origin (Inches)

<ImageSize units="Inches" x="0.1" y="0.1" height=".75" width="2" origin="TopLeft"/>

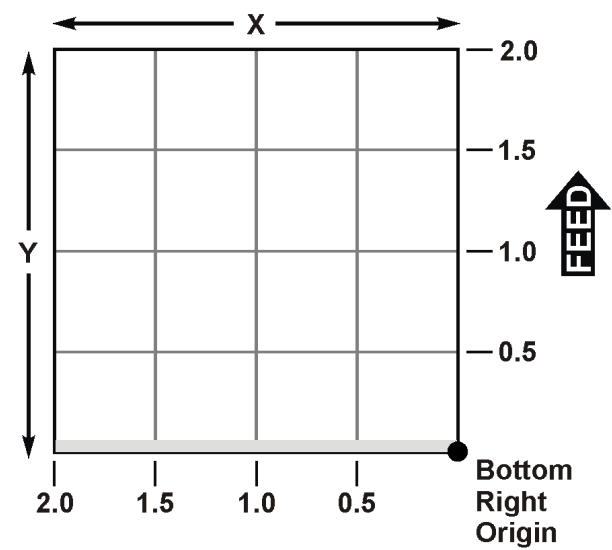
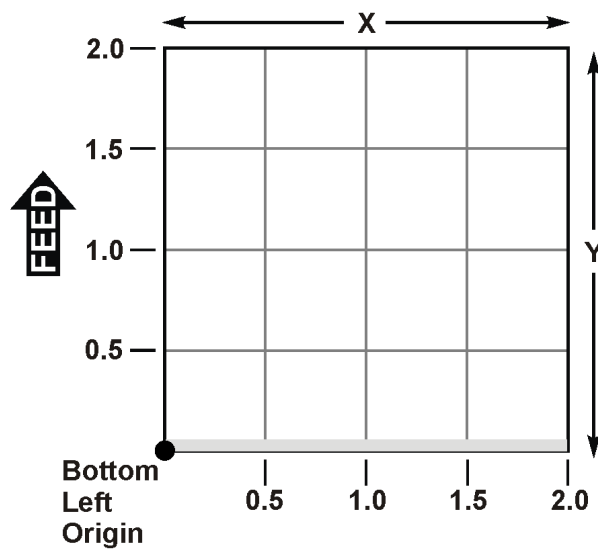
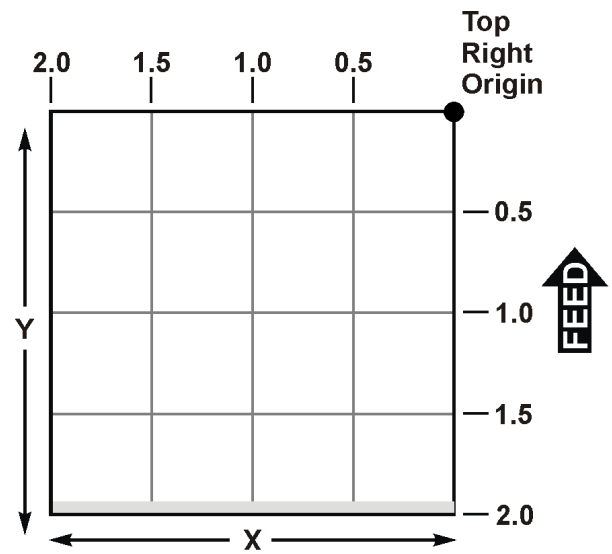
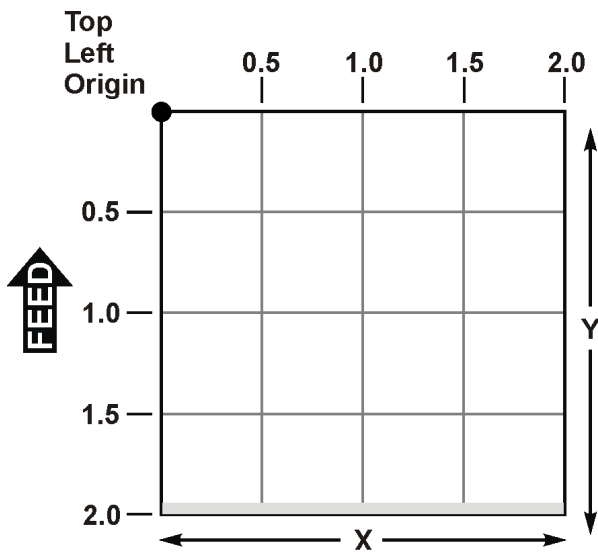

 Indicates a Non-Print Zone of 0.05" on the trailing edge of the label.

Code Page 100 (Macintosh)

240	Ò	Ó	Ô	Ù	ı	^	~	-	˘	˙	˚	˛	˜	˝		
224	‡	·	,	„	%	Â	Ê	Á	Ë	È	Í	Î	Ï	Ò	Ô	
208	-	-	"	"	`	'	÷	◊	ÿ	ÿ	/	€	<	>	fi	fl
192	ı	ı	¬	√	f	≈	Δ	«	»	...	À	Ã	Õ	Œ	œ	
176	∞	±	≤	≥	¥	μ	∂	Σ	Π	π	∫	ª	º	Ω	æ	ø
160	†	°	¢	£	§	•	¶	β	®	©	™	'	¨	≠	Æ	Ø
144	ê	ë	í	ì	î	ï	ñ	ó	ò	ô	ö	õ	ú	ù	û	ü
128	Ä	Å	Ç	É	Ñ	Ö	Ü	á	à	â	ä	ã	ä	ç	é	è
112	p	q	r	s	t	u	v	w	x	y	z	{		}	~	
96	`	a	b	c	d	e	f	g	h	i	j	k	l	m	n	o
80	P	Q	R	S	T	U	V	W	X	Y	Z	[\]	^	_
64	@	A	B	C	D	E	F	G	H	I	J	K	L	M	N	O
48	0	1	2	3	4	5	6	7	8	9	:	;	<	=	>	?
32	!	"	#	\$	%	&	'	()	*	+	,	-	.	/	
16																
0																
	0	1	2	3	4	5	6	7	8	9	10	11	12	13	14	15

Code Page 101 (Wingdings)

240	↩	↑	↓	↶	↷	↸	↹	◻	◻	×	✓	☒	☑	☒		
224	→	↑	↓	↶	↷	↸	↹	↶	↷	↸	↹	↶	↷	↸	↹	
208	↶	↷	↸	↹	↶	↷	↸	↹	↶	↷	↸	↹	↶	↷	↸	↹
192	⌚	⌚	⌚	⌚	⌚	⌚	⌚	⌚	⌚	⌚	⌚	⌚	⌚	⌚	⌚	⌚
176	⊕	⊕	⊕	⊕	⊕	⊕	⊕	⊕	⊕	⊕	⊕	⊕	⊕	⊕	⊕	⊕
160	•	○	○	○	○	○	○	◻	◻	⋄	⋄	⋄	⋄	⋄	⋄	⋄
144	⑤	⑥	⑦	⑧	⑨	⑩	⑪	⑫	⑬	⑭	⑮	⑯	⑰	⑱	⑲	⑳
128	①	②	③	④	⑤	⑥	⑦	⑧	⑨	⑩	⑪	⑫	⑬	⑭	⑮	⑯
112	◻	◻	◻	⋄	⋄	⋄	⋄	⊗	⊗	⊗	⊗	⊗	⊗	⊗	⊗	⊗
96	♁	♂	♂	♂	♂	♂	♂	♂	♂	♂	♂	♂	♂	♂	♂	♂
80	♂	♂	♂	♂	♂	♂	♂	♂	♂	♂	♂	♂	♂	♂	♂	♂
64	♂	♂	♂	♂	♂	♂	♂	♂	♂	♂	♂	♂	♂	♂	♂	♂
48	♂	♂	♂	♂	♂	♂	♂	♂	♂	♂	♂	♂	♂	♂	♂	♂
32	♂	♂	♂	♂	♂	♂	♂	♂	♂	♂	♂	♂	♂	♂	♂	♂
16																
0																
	0	1	2	3	4	5	6	7	8	9	10	11	12	13	14	15

AMERICAS

170 Monarch Lane
Miamisburg, OH 45342
937 865 2123 (direct)
Tel +800 543 6650
(8:00 a.m. – 6:30 p.m., EDT)
Fax +937 865 6663

ASIA

No. 7 Chun Ying Street
Tseung Kwan O Industrial Estate
New Territories, Hong Kong
Tel +852 2372 3169
Fax +852 2995 0014

WESTERN EUROPE

1 Thomas Road
Wooburn Green
Bucks HP10 0PE
Tel +(44) 1628 859500
Fax +(44) 1628 859567

ASIA PACIFIC**NEW SOUTH WALES**

61 Vore Street
Silverwater NSW 2128
Tel +(02) 9647 1833
Fax +(02) 9647 1914
Toll free (Outside Sydney only)



Printer
Solutions