



Retailer's Catalog

Volume 01 2020

Your source for Monarch® labelers, labels and retail merchandising needs.

20% OFF
Reusable Bags

20% OFF
Label Applicators

20% OFF
1155 Introductory Pack

20% OFF
1155 Rainbow Pack

15% OFF
Stock Garment Products

Plus FREE shipping*

On all your favorite
Monarch Brand products



Offers valid until 5/7/2020

*Enjoy FREE SHIPPING on your purchase of Monarch Brand products with an order total of \$250 or more placed online at averydennison.com/shopmonarch. Orders cannot be combined for free shipping. Not valid on phone orders. Use code FREE2020 at checkout. Visit our website for additional details. See additional terms on the last page. Other terms and conditions may apply.

All stock Monarch labelers, labels
and supplies available online at

averydennison.com/shopmonarch

Special Offers

20% off Reusable Bags



2.25 Mil

Super Satin® Ameritote® Reusable Bags

Case of 250
12" x 10" x 4"
Regular Price **\$40.00**
Your Price **\$32.00**

Case of 250
16" x 15" x 6"
Regular Price **\$66.00**
Your Price **\$52.80**

Case of 200
22" x 18" x 8"
Regular Price **\$80.00**
Your Price **\$64.00**



2 Mil

Super Wave Ameritote® Reusable Bags

Case of 250
18" x 15" x 6"
Regular Price **\$65.00**
Your Price **\$52.00**

Case of 250
22" x 18" x 8"
Regular Price **\$95.00**
Your Price **\$76.00**



SAVE
OVER
\$20.00

Reusable Environmental Prints – 100% Recyclable

Case of 250
19-1/2" x 16" x 7"
Regular Price **\$103.00**
Your Price **\$82.40**

Please see page 42 for Merchandising Bags

20% off EasyTouch™ Label Applicators



954141
Regular Price **\$108.00**
Your Price **\$86.40**



954142
Regular Price **\$113.00**
Your Price **\$90.40**



954143
Regular Price **\$115.00**
Your Price **\$92.00**

Please see page 46 for Label Applicators

20% off – Monarch® 1155® Introductory Pack



SAVE
\$58.50

Regular Price **\$292.50**
Your Price **\$234.00**

20% off 1155® Rainbow Pack

One roll of each color, two rolls of fluorescent red.
Total 8,000 labels.

Price per pack 1-3
900994
Regular Price **\$52.80**
Your Price **\$42.24**

BUY
MORE &
SAVE





Monarch® Labelers and Supplies

1-Line - One-line labelers and labels found on pages 7-11.



1110° Labeler



1131° Labeler



1130° Labeler



2-Line
Two-line labelers and labels found on pages 12-17.



1115° Labeler



1135° Labeler

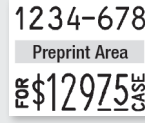

1136° Labeler



1142° Labeler

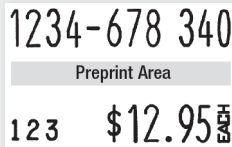

1155° Labeler



3-Line
Three-line labeler and labels found on page 24.

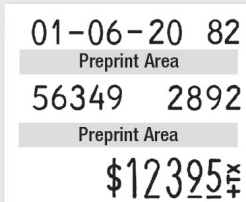

1153° Labeler

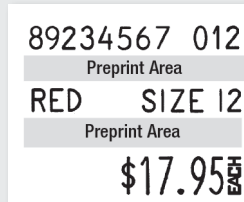

1153° Labeler



Promotional
Promotional labelers and labels found on pages 18-23.



1151° Labeler



1152° Labeler



1138° Labeler



1151°C Labeler

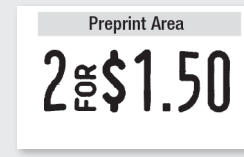

1156° Labeler



Message Labelers
Wordband labelers and labels found on page 20.



1151° CWB Labeler

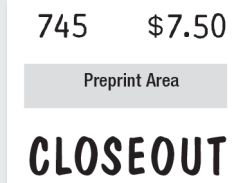

1152° WB Labeler

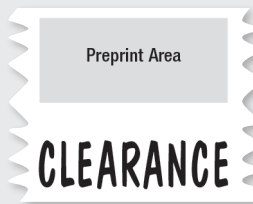

1151° WB Labeler



1156° WB Labeler



Find It Fast Index

Bags On A Roll	41
Bags – Plastic, Paper, Shopping	40-42
Box Cutters	48
Cable Ties and Fasteners	30
Circle/Colored Dot Labels	47
EasyTouch™ Applicator	46
Fastener Tools and Fasteners	26-32
Garment Control Tags	33
General Information	4-6
Gift Certificates	38
Hard Goods Tagging:	
Standard	29
Heavy Duty	30
Jewelry Tags	34
Label Applicators	46
Labeler Accessories	25
Merchandise Tags	35
One-Line Labelers	7-11
Promotional Labelers	18-23
Promotional Sign Cards, Stick on Flags and Starbursts	39
Register Forms	36-38
Security	44
Shelving Labels	39
Shopping Baskets	45
Sidewalk Signs	43
Size Strips/Labels	33
Softlines Tagging:	
Fine Fabric	27
Standard	28
Specialty Tagging:	
Outdoor/Horticulture	31
Food	32
String and Stringless Tags	34
Tabletop Printer Supplies	39
Three-Line Labelers	24
Two-Line Labelers	12-17
Word/Message Labelers	20
Workstations	49

Monarch® Label System

Monarch® Labeler Selector

Use the chart below to select your application requirements and determine which labeler is right for you.

Find it on page	8	10	7	16	12	14	17	22	21	23	18	18	18	20	20	20	20	24	
	1-Line			2-Line				Promotional					Message				3-Line		
Maximum Characters/Line																			
Top				6	8	8	10	12						12			1*	12	12
Middle										7		7		1*	1*			1*	12
Bottom	8	8	6	6	8	8	10	12	5		7		7						12
Message Labelers										•				X	X	X	X		
Price Items Over \$100	X	X	X	X	X	X	X	X		X	X	X	X					X	X
Unit Pricing (pkg., doz., etc.)	•	X	•	•	X	X	X	X	•	X	X	X	X					•	X
Multiple Pricing (2 FOR, etc.)	X	X	X	X	X	X	X	X	X	X	X	X	X					•	X
Two-Line Comparison Pricing				X	X	X	X	X						X					X
Promotional Pricing									X	X	X	X	X						
Raised/Underlined Cents	X	X	X	X	X	X	X	X	•	X	X	X	X						X
Large Print (larger than 5mm)									X	X	X	X	X	X	X	X	X	X	
Date Coding	X	X	•	X	X	X	X	X						X				X	X
Time Coding	X	X	•	X	•	X	•	X						•				•	•
PLU Code	X	X	X	X	X	X	X	X	X		X	X	X						X
SKU Code/Vendor Code	X	X	X	X	X	X	X	X	X		•	•	X						X
Cost Code	•	•	•	•	X	•	•	•						•					•
Alpha Characters	•	•	•	•	•	X	•	•						•				•	X
Part-Gum Labels					X			X			X		X					X	X
Peel-Off "Piggyback" Labels								•											
OUTDOOR™ Labels	•	•	•	•	X	X		X	•	X	•	•	•	•	•	•	•	•	

X - In Stock • - Available 1* - Prints 1 word/line

Don't see a product that meets your unique challenges? Visit us at averydennison.com/shopmonarch or call 1-800-543-6650.

Monarch® Intelligent Retail Solutions

With a huge variety of options to choose from, you're sure to find the right labeler for your price-marking and date-coding job.

From repetitive promotional labeling on fast-turning items to managing inventory with SKUs, alpha codes and more, you can choose between one, two and three-line labelers that are as durable as they are easy and intuitive to use.



All Monarch® labelers are made in the USA with red touchpoints to help simplify the loading process.

Most take 75% less time to load labels and 97% less time to change ink rollers than other labelers on the market.

Instructional videos are easily accessed by scanning the QR code conveniently located on the labeler.

Made from practically indestructible ABS plastic and drop tested to ensure they'll last for decades of normal use, all of our labelers are covered by a one year warranty and we also offer 48-hour turnaround repairs on all labelers.

And don't forget your Monarch® labels. Always insist on genuine Monarch® labels for use in your Monarch® labeler.



We can customize your labeler with the print layout you require! Let one of our trained representatives help you design your labeler's unique layout of letters, numbers and characters.

Call 1-800-543-6650.

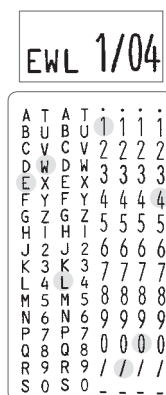

Customized Promotional Labels

Create your own labels with the exact messages you need.

Order custom Monarch® labels in four easy steps:

1. Choose your paper color: fluorescent colors are brighter than shown below. Due to printing processes, actual label color may vary slightly from colors shown.

2. Choose your adhesive: general-purpose or removable.

General-Purpose Adhesive

General-purpose adhesive is available in the below colors and recommended for most pricing applications. Suitable for poly bags and goods intended to be frozen.

White	Yellow	Lt. Blue	Pink
Lt. Green	Fl. Red	Fl. Orange	Fl. Chartreuse
Lilac	Fl. Green	Fl. Pink	Buff

Removable Adhesive

Removable adhesive is available in the below colors and enables label removal without damage to products or packaging.

White	Yellow	Fl. Red
Fl. Orange	Fl. Green	

3. Choose the type style: for your custom printing (select by number).

<i>The Gift Shop</i> your logo	THE GIFT SHOP block type	The Gift Shop reverse type
-----------------------------------	-----------------------------	-------------------------------

E-mail your artwork to:
PSD.customerservice@averydennison.com

- | | | |
|-------------------------|------------------|------------------|
| 1. THE GIFT SHOP | 4. The Gift Shop | 7. The Gift Shop |
| 2. <i>The Gift Shop</i> | 5. The Gift Shop | 8. THE GIFT SHOP |
| 3. <i>The Gift Shop</i> | 6. THE GIFT SHOP | |

4. Choose one ink color for your custom printing: due to printing processes, ink color may vary based on selection of label paper color(s).



Not all labels are the same!

Keep your labeler operating smoothly. Look inside the core to ensure you have *genuine* Monarch® labels. Avery Dennison is ISO 9001:2015 Certified.

Monarch® Repair Service

For repair service call: **800-214-0872**

8:00am - 7:00pm EST

Ship to: Avery Dennison
200 Monarch Lane, Door 37
Miamisburg, Ohio 45342

Sending labeler implies consent of repair. Standard charges listed on Label Repair Form will apply.

Most repairs ship in 1-2 business days after receipt.

Custom Labels

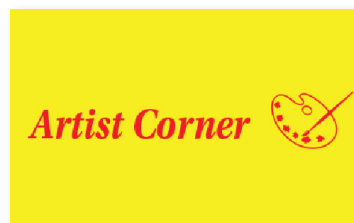
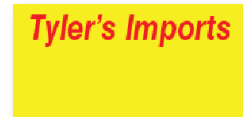
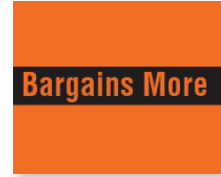

Monarch® Label Applications

Price Switching Prevention



Price switching is a problem nearly every retailer faces. Thieves replace price labels on high value items with labels from lesser value or marked down items, resulting in lost revenue for the store. Help prevent removal and reapplication to other products and reduce losses from price switching by adding security slits to your permanent labels. Check out all of our Monarch security slit labels for a variety of label sizes and labeler formats.

Monarch® 1136® Labels with extra security slits

Tamper evident labels have extra security slits added that prevent label switching by customers. Labels tear apart easily when removal is attempted. 14,000 labels per sleeve.*

*Price Per Sleeve

Quantity	Stock
1	\$79.80
2-3	\$72.10
4-5	\$66.78
6-7	\$61.60
8	\$47.04



906115
Fl. Red

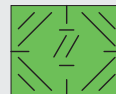

906116
Fl. Green



906117
Fl. Orange



906118
Yellow

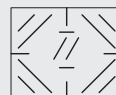

906119
White



906120
Fl. Pink

OUTDOOR™ Wet or High Moisture Environments

Whether you are price marking merchandise inside your store or outdoors where the elements are harsh, we have the labeler/label combination for you!

Durable weather-resistant labels with permanent adhesive are the perfect choice for price marking applications or item identification where the image must stay visible during the life of the product it's placed on. Outdoor pricing remains visible even after 365 days of harsh weather. See pages 10-15, 18-19, 22-23 for additional information.



Monarch® 1131®
One-Line Labeler



FGK-100 (906008)



Monarch® 1136®
Two-Line Labeler



FFK-100 (000010)



Shop Monarch® handheld labelers and labels at averydennison.com/shopmonarch

Date Coding

Handheld labelers save you time and money when pricing or date coding freshly prepared food items or grab-and-go items. Monarch handheld labelers provide clear, concise information that is completely legible reducing food waste and mistakes in food handling. Identify time/date food is prepared or expires to meet food safety requirements and to manage FIFO rotation. See pages 8-9 and 14-15 for additional information.

Monarch® Model 1110-06

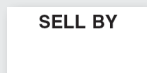
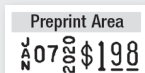

Monarch® Model 1131-02

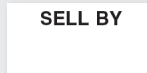

Monarch® Model 1136-02

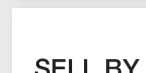
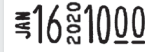

Monarch® 1130® 1 Line Labeler



CUSTOMIZE YOUR LABELER PRINTING
MADE IN THE USA
 Customize your labeler printing
 See page 4

The Monarch® 1130® offers all the standard features of our one-line price-coding labelers with up to six characters. No matter how many items and cases you put in its path, the 1130® can get the job done as its durability, like all our labelers, is second to none.

\$77.00 Each
 1-4 labelers

BUY MORE + SAVE

5-9 labelers **\$72.75** Each
 10+ labelers **\$68.00** Each

1130® Ink Rollers



One ink roller included with every labeler.

\$7.60 Per Roller

Black **11828001**
 Red **11828006**

See page 25 for additional details.

Select from one of the models shown below to meet your marking needs. Each illustrates a different arrangement of print bands.

Model 1130-01 Model 1130-02 Model 1130-03 Model 1130-09

Preprint Area	Preprint Area	Preprint Area	Preprint Area
\$18.95	2 \$195	2 \$98¢	\$128⁵⁰
prints in 6 positions	prints in 6 positions	prints in 6 positions	prints in 6 positions
11 . . 11 22 1 1 2 2 33 2 2 3 3 44 3 3 4 4 55 4 4 5 5 66 5 5 6 6 77 6 6 7 7 88 7 7 8 8 99 8 8 9 9 00 9 9 0 0 \$ \$ 0 0 ¢ ¢ ¢ ¢ // ¢ ¢ / / - - ¢ ¢	111 . 11 222 1 1 2 2 333 2 2 3 3 444 3 3 4 4 555 4 4 5 5 666 5 5 6 6 777 6 6 7 7 888 7 7 8 8 999 8 8 9 9 000 9 9 0 0 \$ \$ \$ 0 ¢ ¢ ¢ ¢ ¢ // ¢ ¢ / / / - - ¢ ¢	1 1 . . 1 1 2 2 1 1 2 2 3 3 2 2 3 3 4 4 3 3 4 4 5 5 4 4 5 5 6 6 5 5 6 6 7 7 6 6 7 7 8 8 7 7 8 8 9 9 8 8 9 9 0 0 9 9 0 0 \$ \$ 0 0 ¢ ¢ ¢ ¢ // ¢ ¢ / / - - ¢ ¢	111 . . . 222 1 1 333 2 2 2 444 3 3 555 4 4 4 666 5 5 5 777 6 6 6 888 7 7 7 999 8 8 8 000 9 9 9 \$ \$ \$ 0 0 0 ¢ ¢ ¢ // ¢ ¢ / / / - - ¢ ¢

Monarch® 1130® Labels

Monarch® 1130® Labels are ideal for labeling smaller products with limited promotional space. Available in bright fluorescents, as preprints, and with the option for customization, 1130® Labels are great easy-to-read labels for all your price and promotional labeling.

ACTUAL SIZE	Fluorescent Red	Fluorescent Red	Fluorescent Yellow	Fluorescent Green
FO-122 (000202)	FO-132 (000205)	FO-700 (906014)	FO-524 (000656)	FO-151 (000214)
	DAIRY	PRODUCE	MEAT	GROCERY
	FO-116 (000648)	FO-118 (000235)	FO-119 (000619)	FO-117 (000225)

Fluorescent labels are brighter than shown here.

1130® Labels

Price Per Sleeve

Quantity	Stock	Custom
1	\$87.00	\$134.00
2	\$79.50	\$109.00
3-5	\$66.25	\$78.00
6-7	\$62.00	\$68.00
8	\$50.25	\$54.25

BUY MORE + SAVE

1130® Labels Standard Packaging

Labels Per Roll: 2,500
 Labels Per Sleeve: 25,000
 Rolls Per Sleeve: 10
 Sleeves Per Case: 8
 Labels Per Case: 200,000

PLUS - One black ink roller included with each sleeve.

Monarch® Custom Labels

See page 5 for easy ordering.

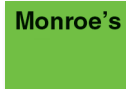

Odds & Ends

All-Purpose Holster



Holster
\$16.50 Each 954144

2" x 42" Polypro Adjustable Belt

\$8.50 Each 954145

This durable, all-purpose holster has four pockets so you can use it for your scrapers, tag attachers and safety cutters in addition to your labeler.

+ Shop Monarch® handheld labelers and labels at averydennison.com/shopmonarch

Monarch® 1110® 1 Line Labeler



\$82.00 Each
1-4 labelers

BUY MORE
SAVE

5-9 labelers **\$77.25** Each
10+ labelers **\$72.75** Each

1110® Ink Rollers



One ink roller included with every labeler.

\$5.95 Per Roller

Black **08394601**
Red **08394606**
Green **08394604**

See page 25 for additional details.

With its ability to price mark unique shapes with limited label space, the Monarch® 1110® is ideal for marking items while still in the carton.

It's so lightweight (9.5 oz. fully loaded) and quick, customers have reported marking 18-item cases in only five seconds.*

Choose the labeler model that best meets your needs.

*Independent results may vary.

Select from one of the models shown below to meet your marking needs. Each illustrates a different arrangement of print bands.

Model 1110-01



prints in 6 positions

1 1 1 1 1 1
2 2 2 2 2 2
3 3 3 3 3 3
4 4 4 4 4 4
5 5 5 5 5 5
6 6 6 6 6 6
7 7 7 7 7 7
8 8 8 8 8 8
9 9 9 9 9 9
0 0 0 0 0 0
FOR \$ \$ \$ \$ \$ \$
EACH \$ \$ \$ \$ \$ \$

Model 1110-02



prints in 6 positions

1 1 1 1 1 1
2 2 2 2 2 2
3 3 3 3 3 3
4 4 4 4 4 4
5 5 5 5 5 5
6 6 6 6 6 6
7 7 7 7 7 7
8 8 8 8 8 8
9 9 9 9 9 9
0 0 0 0 0 0
FOR \$ \$ \$ \$ \$ \$
EACH \$ \$ \$ \$ \$ \$
+TX +TX +TX +TX +TX +TX

Model 1110-03

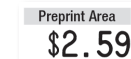

prints in 5 positions

1 1 1 1 1
2 2 2 2 2
3 3 3 3 3
4 4 4 4 4
5 5 5 5 5
6 6 6 6 6
7 7 7 7 7
8 8 8 8 8
9 9 9 9 9
0 0 0 0 0
FOR \$ \$ \$ \$ \$
EACH \$ \$ \$ \$ \$
+TX +TX +TX +TX +TX

Model 1110-04



prints in 7 positions

1 1 1 1 1 1 1
2 2 2 2 2 2 2
3 3 3 3 3 3 3
4 4 4 4 4 4 4
5 5 5 5 5 5 5
6 6 6 6 6 6 6
7 7 7 7 7 7 7
8 8 8 8 8 8 8
9 9 9 9 9 9 9
0 0 0 0 0 0 0
10 0 0 0 0 0 0
11 \$ \$ \$ \$ \$ \$ \$
12 FOR \$ \$ \$ \$ \$ \$ \$
EACH \$ \$ \$ \$ \$ \$ \$

Model 1110-05



prints in 8 positions

1 1 1 1 1 1 1 1
2 2 2 2 2 2 2 2
3 3 3 3 3 3 3 3
4 4 4 4 4 4 4 4
5 5 5 5 5 5 5 5
6 6 6 6 6 6 6 6
7 7 7 7 7 7 7 7
8 8 8 8 8 8 8 8
9 9 9 9 9 9 9 9
0 0 0 0 0 0 0 0
\$ \$ \$ \$ \$ \$ \$ \$
EACH \$ \$ \$ \$ \$ \$ \$ \$

Model 1110-06

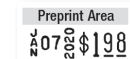

prints in 8 positions

1 1 1 1 1 1 1 1
2 2 2 2 2 2 2 2
3 3 3 3 3 3 3 3
4 4 4 4 4 4 4 4
5 5 5 5 5 5 5 5
6 6 6 6 6 6 6 6
7 7 7 7 7 7 7 7
8 8 8 8 8 8 8 8
9 9 9 9 9 9 9 9
0 0 0 0 0 0 0 0
5 0 0 0 0 0 0 0
FOR \$ \$ \$ \$ \$ \$ \$ \$
EACH \$ \$ \$ \$ \$ \$ \$ \$

+ Shop Monarch® handheld labelers and labels at averydennison.com/shopmonarch

Monarch® 1110® 1 Line Labeler



A History of Innovation

In 1890 the first machine to label merchandise was invented and Monarch® was born. Through the years as the marketplace changed and technology advanced, Monarch® became an industry leader. In 1972 our company revolutionized pricemarking with the introduction of the Monarch® 1110® Labeler.

Keep Your 1110® Labelers Operating Smoothly!



1110® Maintenance Kit

Kit contains:

1. One ½ oz. bottle of silicone lubricant
2. One label removal strip
3. Six ink roller carriers
4. Six ink roller covers
5. Six door latches
6. Two ink rollers and operating instructions.

For the Monarch® 1110® Labeler
\$45.00 Per Kit
 119919

**SAVE
OVER
\$91.00**

Monarch® Custom Labels

See page 5 for easy ordering.

LAWTON DRUGS

Dawn's Jeans

Monarch® 1110® Labels

With great readability and strong adhesives, Monarch® 1110® labels feature security slits that help avert price switching by tearing when removal is attempted.

Shown with Security Slits

ACTUAL SIZE
Fluorescent Red

FEB-122 (000542)
REB-114 (000534)

FEB-132 (000578)
REB-115 (000535)

SALE PRICE	SALE	DISCOUNT	SPECIAL
REB-135 (000507)	REB-113 (000533)	FEB-129 (000575)	FEB-128 (000574)
Fluorescent Green	Fluorescent Orange		GENERAL MDSE.
FEB-151 (000896)	FEB-125 (000928)	FEB-524 (000518)	FEB-502 (000389)
SELL BY	USE BY	GROCERY	GROCERY
FEB-534 (000557)	FEB-712 (000571)	FEB-10 (000501)	FEB-117 (000537)
DELI	PRODUCE	PRODUCE	FROZEN
FEB-120 (000540)	Fluorescent Green	FEB-118 (000538)	FEB-121 (000541)
FEB-116 (000536)	FEB-134 (000629)	FEB-133 (000628)	FEB-152 (000005)
DAIRY	SEAFOOD	BAKERY	FLORAL
FEB-116 (000536)	FEB-147 (000892)	FEB-133 (000628)	Fluorescent Green
ORGANIC			
Fluorescent Green			
FEB-1 (906097)	FEB-701 (906107)		

FEB – General-Purpose Adhesive
 REB – Removable Adhesive

Fluorescent labels are brighter than shown here.

Additional labels available online: averydennison.com/shopmonarch

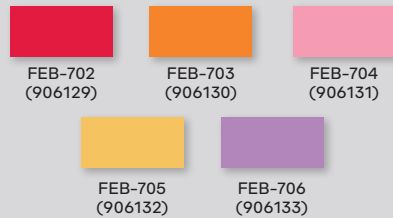

1110® Labels

Price Per Sleeve

Quantity	Stock	Custom
1	\$62.22	\$95.71
2	\$56.78	\$78.03
3	\$50.49	\$65.28
4-5	\$47.43	\$55.93
6-14	\$44.20	\$48.45
15	\$35.87	\$38.93

1110® Labels Standard Packaging

Labels Per Roll: 1,063
 Labels Per Sleeve: 17,000
 Rolls Per Sleeve: 16
 Sleeves Per Case: 15
 Labels Per Case: 255,000

PLUS - One black ink roller included with each sleeve.

Monarch® 1131® 1 Line Labeler



CUSTOMIZE YOUR LABELER PRINTING
MADE IN THE USA
 Customize your labeler printing
 See page 4



\$82.00 Each

1-4 labelers

5-9 labelers **\$77.25** Each

10+ labelers **\$72.75** Each



1131® Ink Rollers



One ink roller included with every labeler.

\$7.60 Per Roller

Black **11828001**

Red **11828006**

See page 25 for additional details.

The Monarch® 1131® is our most popular labeler. Able to print prices, dates, units-of-measure and prices for multiples while using up to eight characters, the Monarch® 1131® is ideal for dating food that was prepared in advance as well as pricing merchandise often bought in bulk.

Select from one of the models shown below to meet your marking needs. Each illustrates a different arrangement of print bands.

Model 1131-01 Model 1131-02 Model 1131-03 Model 1131-09

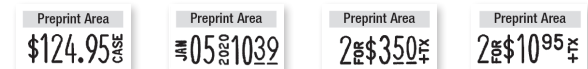

prints in 8 positions prints in 8 positions prints in 8 positions prints in 8 positions

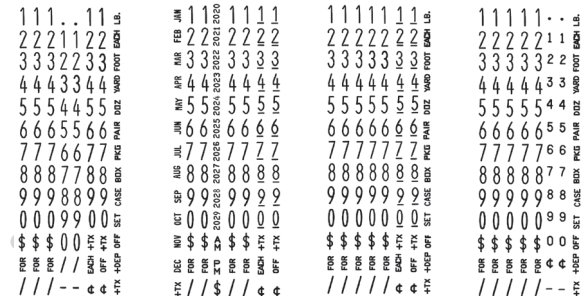

Prints crisp, clear labels for excellent legibility and reduced errors.

Introductory Package

Everything you need to start marking your merchandise.

- 1 Monarch® Labeler (1131-01)
- 1 sleeve bright white labels
- 1 holster and 1 belt
- 1 black ink roller
- 1 label scraper



SAVE OVER \$22.00

1131 Labeler Intro Package
 Total Value \$188.70

\$166.00 Per Kit
 IP-1131

+ Shop Monarch® handheld labelers and labels at averydennison.com/shopmonarch

Monarch® 1131® Labels

With over 20 different designs to choose from, Monarch® 1131® Labels meet your everyday marking needs.



FG-122 (000239)
RG-114 (000036)

RG - Removable Adhesive
FGA - Meets FDA Specs
(Adhesive for use on edible surfaces)



Fluorescent Red

FG-132
(000240)



FG-188
(000021)



FG-189
(906088)



Fluorescent Red

RG-113
(000024)

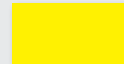

FG-524
(900218)



Fluorescent Orange

FG-125
(000145)

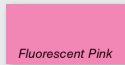

Fluorescent Pink

FG-154
(000144)



Fluorescent Pink

FG-633
(900222)



Fluorescent Green

FG-151
(000652)



Fluorescent Green

FG-533
(000600)



Fluorescent Green

FGA-600
(900221)



Fluorescent Green

FG-713
(000653)



USE BY

FG-712
(000241)

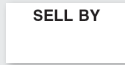

SELL BY

FG-534
(000614)



GROCERY

FG-117
(000631)



GEN MOSE

FG-504
(000565)



DELI

FG-120
(000515)



PRODUCE

FG-118
(000496)



BAKERY

FG-133
(000564)



SEAFOOD

FG-147
(000236)



ORGANIC

FGA-1131
(906009)



DAIRY

FG-116
(900219)



COSMETICS

FG-112
(900169)



MEAT

FG-119
(000499)

Fluorescent labels are brighter than shown here.

1131® Labels

Price Per Sleeve

Quantity	Stock	Custom
1	\$73.20	\$112.60
2	\$66.80	\$91.80
3-5	\$55.80	\$65.80
6-7	\$52.00	\$57.00
8	\$42.00	\$45.80



1131® Labels Standard Packaging

Labels Per Roll 2,500
Labels Per Sleeve 20,000
Rolls Per Sleeve 8
Sleeves Per Case 8
Labels Per Case 160,000

PLUS - One black ink roller included with each sleeve.

Durable OUTDOOR™ Labels

Weather-resistant, synthetic OUTDOOR™ labels with all-temperature adhesive suitable for most outdoor environments and exposure to some chemicals.

One black ink roller included with each sleeve. 16,000 labels per sleeve.



FGK-100
(906008)

For custom labels call 1-800-543-6650.

Price Per Sleeve

1	2	3-5	6-7	8
\$87.04	\$81.92	\$63.36	\$60.32	\$52.48



Monarch® Repair Service

For repair service call:
800-214-0872

8:00am - 7:00pm EST

Ship to: Avery Dennison
200 Monarch Lane, Door 37
Miamisburg, Ohio 45342

Sending labeler implies consent of repair. Standard charges listed on Label Repair Form will apply.

Most repairs ship in 1-2 business days after receipt.

Monarch® Custom Labels

Joe's Market

LAWTON DRUGS

See page 5 for easy ordering.

Genuine Monarch® Labels



For quality labels, look inside the core for the Monarch® name.

Monarch® 1115® 2 Line Labeler



Available in several models that incorporate a number of different characters and positions, the Monarch® 1115® can handle nearly any price-marking task you give it, including unit or comparison pricing, "was/now" labeling, even cost-coding.



\$132.25 Each
1-4 labelers

\$129.00 Each
5-9 labelers

\$124.50 Each
10+ labelers



1115® Ink Rollers



One ink roller included with every labeler.

\$5.95 Per Roller

Black **08968801**

See page 25 for additional details.



Shop Monarch® handheld labelers and labels at averydennison.com/shopmonarch

Select from one of the models shown below to meet your marking needs. Each illustrates a different arrangement of print bands.

Model 1115-01 prints in 12 positions	Model 1115-02 prints in 13 positions	Model 1115-04 prints in 16 positions
<p>JAN 12-20 Preprint Area \$109^{TX}</p>	<p>99¢ Preprint Area \$10.50^{DOZ}</p>	<p>123 5678 Preprint Area 2¢ \$10⁹⁹</p>
<p>Top line</p> <p>JAN 1 1 1 1 1 1 EA FEB 2 2 2 2 2 2 MAR 3 3 3 3 3 3 APR 4 4 4 4 4 4 MAY 5 5 5 5 5 5 LB PLY DOZ FT EA JUN 6 6 6 6 6 6 JUL 7 7 7 7 7 7 PT OZ AUG 8 8 8 8 8 8 SEP 9 9 9 9 9 9 GAL DT OCT 0 0 0 0 0 0 NOV \$ \$ \$ DEC FOR \$ \$ - - - - ¢</p>	<p>Top line</p> <p>1 1 1 1 1 1 1 2 2 2 2 2 2 2 3 3 3 3 3 3 3 4 4 4 4 4 4 4 5 5 5 5 5 5 5 6 6 6 6 6 6 6 7 7 7 7 7 7 7 8 8 8 8 8 8 8 9 9 9 9 9 9 9 0 0 0 0 0 0 0 \$ \$ ¢ FOR \$ \$ - - - - ¢</p>	<p>Top line</p> <p>1 1 1 1 1 1 1 1 2 2 2 2 2 2 2 2 3 3 3 3 3 3 3 3 4 4 4 4 4 4 4 4 5 5 5 5 5 5 5 5 6 6 6 6 6 6 6 6 7 7 7 7 7 7 7 7 8 8 8 8 8 8 8 8 9 9 9 9 9 9 9 9 0 0 0 0 0 0 0 0 \$ \$ \$ \$ / / / / / \$ \$</p>
<p>Bottom line</p> <p>1 1 1 1 1 1 2 2 2 2 2 2 3 3 3 3 3 3 4 4 4 4 4 4 5 5 5 5 5 5 6 6 6 6 6 6 7 7 7 7 7 7 8 8 8 8 8 8 9 9 9 9 9 9 0 0 0 0 0 0 \$ \$. \$ ¢ FOR \$ \$ / \$ ¢ +TX +TX</p>	<p>Bottom line</p> <p>1 1 1 . 1 1 2 2 2 2 2 3 3 3 . 3 3 4 4 4 . 4 4 5 5 5 . 5 5 6 6 6 . 6 6 7 7 7 . 7 7 8 8 8 . 8 8 9 9 9 . 9 9 0 0 0 . 0 0 \$ \$ \$ \$ ¢ FOR \$ \$ \$ \$ ¢ +TX +TX ¢ N/A ¢ LB. CASE BOX PNG PAIR DOZ YARD FOOT EACH</p>	<p>Bottom line</p> <p>1 1 1 1 1 1 1 1 2 2 2 2 2 2 2 2 3 3 3 3 3 3 3 3 4 4 4 4 4 4 4 4 5 5 5 5 5 5 5 5 6 6 6 6 6 6 6 6 7 7 7 7 7 7 7 7 8 8 8 8 8 8 8 8 9 9 9 9 9 9 9 9 0 0 0 0 0 0 0 0 \$ \$ \$ \$ ¢ FOR \$ \$ \$ \$ ¢ FOR \$ \$ \$ \$ ¢ FOR \$ \$ \$ \$ ¢ FOR \$ \$ \$ \$ ¢ EA. ¢ ¢</p>

Monarch® 1115® Labels

Monarch® 1115® Labels offer two lines of variable print. Labels come standard with security slits for added protection from price switching.



FM-312 (900449)
RM-313 (900450)



FM-346 (000298)
RM-316 (900436)

Fluorescent labels are brighter than shown here.



RM-315 (900452)



FM-390 (000861)



RM-321 (900433)



FM-305 (900442)



RM-322 (900434)



PMGF-325 (900445)



FM-341 (000258)



FM-540 (000636)

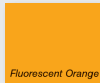

FM-556 (000661)



FM-301 (900438)

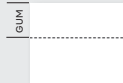

FMGC-310 (900447)



FM-302 (900439)



FM-351 (000561)



FM-300 (900437)



FM-343 (000265)



FM-342 (000259)



FM-800 (906109)

FM – General-Purpose Adhesive RM – Removable Adhesive

1115® Labels

Price Per Sleeve

BUY MORE + SAVE

Quantity	Stock	Custom
1	\$85.50	\$111.45
2	\$77.25	\$89.10
3	\$71.55	\$79.95
4-5	\$65.85	\$73.35
6-7	\$58.65	\$66.00
8-15	\$50.40	\$55.80
16	\$46.20	\$50.10

PLUS - One black ink roller included with each sleeve.

1115® Labels Standard Packaging

Labels Per Roll 1,500
Labels Per Sleeve 15,000
Rolls Per Sleeve 10
Sleeves Per Case 16
Labels Per Case 240,000

Durable OUTDOOR™ Labels

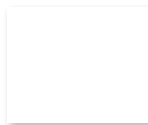

FMK-100 (900446)

Weather-resistant, durable OUTDOOR™ labels with all-temperature adhesive are suitable for most outdoor environments and exposure to some chemicals.

Price Per Sleeve*

1	2-3	4-6	7-9	10
\$71.70	\$66.00	\$62.40	\$58.50	\$48.30

*Quantity: 10,000 labels per sleeve

BUY MORE + SAVE

One black ink roller included with each sleeve. 15,000 labels per sleeve.

For custom labels call 1-800-543-6650.

124 PRTE

Preprint Area

\$19.95 PKG.

Model 1115-05*

prints in 14 positions

Top line

1 1 1 1 P
2 2 2 2 A
3 3 3 3 T
4 4 4 4 H
5 5 5 5 F
6 6 6 6 I
7 7 7 7 N
8 8 8 8 D
9 9 9 9 E
10 0 0 0 R
11 \$ \$ X X
12 FOR FOR Y Y
1-3 4-7

Bottom line

1 1 1 1 1 1
2 2 2 2 2 2
3 3 3 3 3 3
4 4 4 4 4 4
5 5 5 5 5 5
6 6 6 6 6 6
7 7 7 7 7 7
8 8 8 8 8 8
9 9 9 9 9 9
0 0 0 0 0 0
FOR FOR FOR FOR
EACH EACH EACH EACH
NITX + TX OZ. LB. CASE BOX PKG. PAIR DOZ. YARD FOOT EACH

0627 -20

Preprint Area

5¢ \$29.95 PKG.

Top line

1 1 1 1 1 1 1
2 2 2 2 2 2 2
3 3 3 3 3 3 3
4 4 4 4 4 4 4
5 5 5 5 5 5 5
6 6 6 6 6 6 6
7 7 7 7 7 7 7
8 8 8 8 8 8 8
9 9 9 9 9 9 9
0 0 0 0 0 0 0
- - - - - - -

Model 1115-06

prints in 14 positions

Bottom line

1 1 1 1 1 1 1
2 2 2 2 2 2 2
3 3 3 3 3 3 3
4 4 4 4 4 4 4
5 5 5 5 5 5 5
6 6 6 6 6 6 6
7 7 7 7 7 7 7
8 8 8 8 8 8 8
9 9 9 9 9 9 9
0 0 0 0 0 0 0
FOR FOR FOR FOR
EACH EACH EACH EACH
NITX + TX OZ. LB. CASE BOX PKG. PAIR DOZ. YARD FOOT EACH

\$ 12.00

Preprint Area

12 \$10.99

Model 1115-72

prints in 16 positions

Call TOLL-FREE for details on these models

0214-20

Preprint Area

\$13.50

Model 1115-73

prints in 14 positions

Monarch® Custom Labels

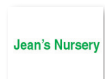

See page 5 for easy ordering.

Positions 4-7 are *Cost Code bands with alpha characters.

Monarch® 1136® 2 Line Labeler



\$132.25 Each
 1-4 labelers
 5-9 labelers **\$129.00** Each
 10+ labelers **\$124.50** Each

BUY MORE
 SAVE

1136® Ink Rollers



One ink roller included with every labeler.

\$7.60 Per Roller

Black **11828001**

Red **11828006**

See page 25 for additional details.

With ample character space, you can keep track of inventory from the sales floor - including slow-moving or expiring items with the Monarch® 1136®. This two-line labeler, with eight positions on each line, easily accommodates "was"/"now" labeling while also offering you the ability to print months, years, units, SKUs and alpha codes.



Retailing Tip

Our customers have had success using red ink on white labels for eye-catching, promotional pricing. One labeler is used for items at regular price and another labeler, with a red ink roller, for markdown pricing.

+ Shop Monarch® handheld labelers and labels at [averydennison.com/shopmonarch](https://www.averydennison.com/shopmonarch)

Select from one of the models shown below to meet your marking needs. Each illustrates a different arrangement of print bands.

4071-568

Preprint Area

\$129.00 SAVE

Model
 1136-01
 prints in 16 positions

Top line	Bottom line
. 1 1 1 1 1 1 1 1 2 2 2 2 2 2 2 2 3 3 3 3 3 3 3 3 4 4 4 4 4 4 4 4 5 5 5 5 5 5 5 5 6 6 6 6 6 6 6 6 7 7 7 7 7 7 7 7 8 8 8 8 8 8 8 8 9 9 9 9 9 9 9 9 0 0 0 0 0 0 0 0 FEB MAR APR MAY JUN JUL AUG SEP OCT NOV DEC JAN FEB MAR APR MAY JUN JUL AUG SEP OCT NOV DEC UNIT YEARS MONTHS DOLLARS CENTS / / / / / / / /	1 1 1 . . 1 1 2 2 2 1 1 2 2 3 3 3 2 2 3 3 4 4 4 3 3 4 4 5 5 5 4 4 5 5 6 6 6 5 5 6 6 7 7 7 6 6 7 7 8 8 8 7 7 8 8 9 9 9 8 8 9 9 0 0 0 9 9 0 0 FEB MAR APR MAY JUN JUL AUG SEP OCT NOV DEC JAN FEB MAR APR MAY JUN JUL AUG SEP OCT NOV DEC UNIT YEARS MONTHS DOLLARS CENTS / / / / / / / /

JAN 10-850

Preprint Area

2020

Model
 1136-02
 prints in 16 positions

Top line	Bottom line
JAN 10-850 FEB MAR APR MAY JUN JUL AUG SEP OCT NOV DEC JAN 16-2020 FEB MAR APR MAY JUN JUL AUG SEP OCT NOV DEC UNIT YEARS MONTHS DOLLARS CENTS / / / / / / / /	JAN 11-2020 FEB MAR APR MAY JUN JUL AUG SEP OCT NOV DEC JAN 16-2020 FEB MAR APR MAY JUN JUL AUG SEP OCT NOV DEC UNIT YEARS MONTHS DOLLARS CENTS / / / / / / / /

16YELLOW

Preprint Area

\$24.95 SAVE

Model
 1136-03
 prints in 16 positions

Top line	Bottom line
AT BU CV DW EX FY GZ HI J2 K3 L4 M5 N6 P7 Q8 R9 S0 The eight top band are print- around bands with the letters A-Z (except I and O) and the numbers 1-0	1 1 1 . . 1 1 2 2 2 1 1 2 2 3 3 3 2 2 3 3 4 4 4 3 3 4 4 5 5 5 4 4 5 5 6 6 6 5 5 6 6 7 7 7 6 6 7 7 8 8 8 7 7 8 8 9 9 9 8 8 9 9 0 0 0 9 9 0 0 FEB MAR APR MAY JUN JUL AUG SEP OCT NOV DEC JAN FEB MAR APR MAY JUN JUL AUG SEP OCT NOV DEC UNIT YEARS MONTHS DOLLARS CENTS / / / / / / / /

Monarch® 1151®, 1151°C and 1152® Promotional Labelers



The Monarch® 1151® and 1151°C print on jumbo labels that include options with serrated edges and bold, pre-printed promotional messages. The Monarch® 1152® is similar to the 1151®, but with an additional line of print to display more information for date coding and inventory tracking.

With the 1152® you can use up to 19 positions on two lines that enable you to print multiple prices, including “2-for” and “each” pricing on jumbo labels. Select the model number with the print set up that meets your marking needs.

1151® and 1151C® Labelers
(One line of print)

\$154.00 Each

1-4 labels



5-9 labels **\$145.50** Each
10+ labels **\$126.25** Each

PLUS - One black ink roller included with every labeler. Call for higher quantity price breaks.

1152® Labeler
(Two lines of print)

\$174.50 Each

1-4 labels



5-9 labels **\$154.00** Each
10+ labels **\$144.50** Each

PLUS - One black ink roller included with every labeler. Call for higher quantity price breaks.

Select from one of the models shown below to meet your marking needs. Each illustrates a different arrangement of print bands.

Model 1151-01

prints in 7 positions

Model 1152-01

prints in 19 positions
12 top line/7 bottom

Model 1151-02

prints in 7 positions

Model 1152-02

prints in 19 positions
12 top line/7 bottom

Model 1151-03

prints in 7 positions

Model 1151°C

prints 7 characters in center of the label

1 1 1 1 1 1 1
2 2 2 2 2 2 2
3 3 3 3 3 3 3
4 4 4 4 4 4 4
5 5 5 5 5 5 5
6 6 6 6 6 6 6
7 7 7 7 7 7 7
8 8 8 8 8 8 8
9 9 9 9 9 9 9
0 0 0 0 0 0 0
\$ \$ \$ \$ \$ \$ \$
Z FOR FOR FOR FOR FOR

1 1 1 . 1 1
2 2 2 1 1 2 2
3 3 3 2 2 3 3
4 4 4 3 3 4 4
5 5 5 4 4 5 5
6 6 6 5 5 6 6
7 7 7 6 6 7 7
8 8 8 7 7 8 8
9 9 9 8 8 9 9
0 0 0 9 9 0 0
\$ \$ \$ 0 0 \$ \$ \$
Z FOR FOR FOR FOR FOR

.
1 1 1 1 1 1 1 1 1 1 1
2 2 2 2 2 2 2 2 2 2 2
3 3 3 3 3 3 3 3 3 3 3
4 4 4 4 4 4 4 4 4 4 4
5 5 5 5 5 5 5 5 5 5 5
6 6 6 6 6 6 6 6 6 6 6
7 7 7 7 7 7 7 7 7 7 7
8 8 8 8 8 8 8 8 8 8 8
9 9 9 9 9 9 9 9 9 9 9
0 0 0 0 0 0 0 0 0 0 0
\$ \$ \$ \$ \$ \$ \$ \$ \$ \$ \$
FOR FOR FOR FOR FOR FOR FOR FOR FOR FOR FOR
/ / / / / / / / / / /

Top Line for both 1152 models

Monarch® 1151® and 1152® Labels

Fluorescent labels are brighter than shown here.

FXE – General-Purpose Adhesive
RXE – Removable Adhesive

FXSE-900 (900912)
FXSE-901 (900934)
FXSE-912 (900915)
FXSE-910 (900943)
FXE-910 (900921)
FXE-900 (900914)
RXE-900 (900901)
FXE-962 (900908)
FXE-813 (906099)
FXE-901 (900902)
RXE-901 (900903)
FXE-812 (900900)
RXSE-904 (900925)
RXSE-976 (900942)
FXEGC-989 (900959)

Additional labels available online: averydennison.com/shopmonarch

1151®/1152®/1176®/1177® Labels

Price Per Sleeve

Quantity	Stock	Custom
1-3	\$52.86	\$83.64
4-5	\$44.94	\$69.12
6-7	\$40.86	\$62.04
8-9	\$39.36	\$55.74
10-15	\$34.56	\$50.52
16	\$32.70	\$46.50

Monarch® 1176® and 1177® use the same labels as the 115X series on page 19.

PLUS – One black ink roller included with each sleeve.

1151®/1152® Labels Standard Packaging

Labels Per Roll 1,000
Labels Per Sleeve 6,000
Rolls Per Sleeve 6
Sleeves Per Case 16
Labels Per Case 96,000

1151® and 1152® Ink Rollers



One ink roller included with every labeler.

\$7.60

Per Roller

Black **12077801**
OUTDOOR™ Black **12406801**

See page 25 for additional details.

Durable OUTDOOR™ Labels

Weather-resistant, durable OUTDOOR™ labels with all-temperature adhesive suitable for most outdoor environments and exposure to some chemicals.

833 labels/roll, 6 rolls/sleeve, 5M labels/sleeve, 16 sleeves/case, 80M labels/case.

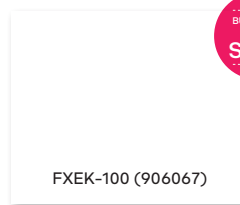

Price Per Sleeve

Quantity	Stock
1-3	\$58.65
4-5	\$52.10
6-7	\$48.70
8-9	\$47.45
10-15	\$43.45
16	\$41.90

All-Purpose Holster



Holster

\$16.50 Each 954144

This highly durable all-purpose holster has four pockets so you can use it for your scrapers, tag attachers and safety cutters in addition to your labeler.



2" x 42" Polypro Adjustable Belt

\$8.50 Each 954145

Monarch® Repair Service

For repair service call: **800-214-0872**

8:00am - 7:00pm EST

Ship to: Avery Dennison
200 Monarch Lane, Door 37
Miamisburg, Ohio 45342

Sending labeler implies consent of repair. Standard charges listed on Label Repair Form will apply.

Most repairs ship in 1-2 business days after receipt.

Monarch® Custom Labels



See page 5 for easy ordering.

Monarch[®] Sure-Sell[™] Word/ Message Labeler



The Monarch[®] Sure-Sell[™] word/message labelers enable use of one labeler with up to 12 different words.

Utilize the 12 most frequently used words or choose from a library of more than 370 additional words. Enables variable message labeling with the turn of knob and without switching labels.

Additional words/messages available

Pick your word or message... Just dial, click and stick!

Sample selection of words!



PROMOTION
26 messages available



DELI
48 messages available



PRODUCE
21 messages available



DAIRY
8 messages available



MEAT
99 messages available



INDUSTRIAL
12 messages available



BAKERY
43 messages available



INTERNATIONAL
61 messages available



FRESHNESS
25 messages available

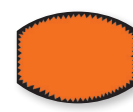

FXOP-941 (900941)
Fluorescent Red



FXOP-901 (900940)
Fluorescent Red

Ask about country of origin labeling!

1151[®] CWB

Prints message in the center of the label
M01151CWB



1151[®] WB

Prints message at the bottom, leaves room for custom preprint
M01151WB

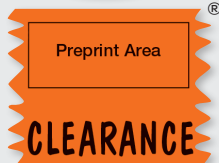

1156[®] WB

Prints message in the center of a smaller label
M01156WB



\$179.00 Each
1-4 labels

5-9 labels **\$168.25** Each
10+ labels **\$146.50** Each

1152[®] WB

Prints message at the bottom, plus allows variable information to be dialed on top line
M01152WB



\$199.50 Each
1-4 labels

5-9 labels **\$179.00** Each
10+ labels **\$169.50** Each

Call for higher quantity price breaks.
One ink roller included with every labeler!

Stock Labels for M01151[®]C or M01151[®]CWB

Price Per Sleeve

1-3	4-5	6-7	8-9	10
\$52.86	\$44.94	\$40.86	\$39.36	\$34.56



PLUS - One black ink roller included with each sleeve. 6,000 labels per sleeve.



Shop Monarch[®] handheld labelers and labels at averydennison.com/shopmonarch

Many label designs and colors available.
For a complete listing and pricing, see page 19 (1151/1152) and page 23 (1156).

Monarch® 1138® Promotional Labeler



Different label shapes draw attention!



Monarch® 1138® Labels

Monarch® 1138® Labels make a big impact with a small space. These compact-size labels with large variable print grab customers' attention with a unique banner/wave label design.



FFP-312 (000210)

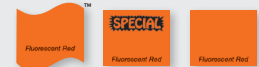

FFPB-910 (000208) FFP-903 (000197) FFP-346 (000219)
 BANR

Fluorescent labels are brighter than shown here.

1138® Labels

Price Per Sleeve

Quantity	Stock	Custom
1	\$79.80	\$104.16
2-3	\$72.10	\$83.16
4-5	\$66.78	\$74.62
6-7	\$61.60	\$68.46
8	\$47.04	\$52.08

PLUS - One black ink roller included with each sleeve.

1138® Labels Standard Packaging

Labels Per Roll 1,750
 Labels Per Sleeve 14,000
 Rolls Per Sleeve 8
 Sleeves Per Case 8
 Labels Per Case 112,000

\$117.50 Each
 1-4 labelers



1138® Ink Rollers



One ink roller included with every labeler.

\$7.60 Per Roller

Black **11962401**

See page 25 for additional details.

The Monarch® 1138® has five positions perfect for labeling large volumes of high-turnover, impulse items. With large, bold print on large format fluorescent labels, your customers are sure to notice.

Enjoy "2-for" pricing along with underscored cents symbol.

Select the model number with the print set up that meets your marking needs.

Select from one of the models shown below to meet your marking needs. Each illustrates a different arrangement of print bands.

Model 1138-01



prints in 5 positions

1 1 1 1 1
 2 2 2 2 2
 3 3 3 3 3
 4 4 4 4 4
 5 5 5 5 5
 6 6 6 6 6
 7 7 7 7 7
 8 8 8 8 8
 9 9 9 9 9
 0 0 0 0 0
 \$ \$. ¢ ¢
 2 FOR FOR 2 TX TX

Model 1138-02



prints in 5 positions

1 1 1 1 1
 2 2 2 2 2
 3 3 3 3 3
 4 4 4 4 4
 5 5 5 5 5
 6 6 6 6 6
 7 7 7 7 7
 8 8 8 8 8
 9 9 9 9 9
 0 0 0 0 0
 \$ \$. ¢ ¢
 2 FOR FOR 2 TX TX

Monarch® Custom Labels



See page 5 for easy ordering.

Monarch® Repair Service

For repair service call:
800-214-0872

8:00am - 7:00pm EST

Ship to: Avery Dennison
 200 Monarch Lane, Door 37
 Miamisburg, Ohio 45342

Sending labeler implies consent of repair. Standard charges listed on Label Repair Form will apply.

Most repairs ship in 1-2 business days after receipt.

Durable OUTDOOR™ Labels

See page 15 for easy ordering

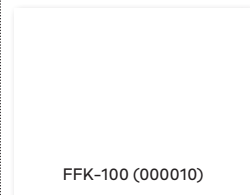

FFK-100 (000010)

Monarch® 1155® Promotional Labeler



The Monarch® 1155® Labeler can print two more characters per line than the 1142® (up to 24 positions on two lines). Its large, bold print on large format fluorescent labels will grab your customers' attention and with the increased character options you can print more detailed codes, dates and unit pricing if necessary.

\$227.50 Each

1-4 labelers

5-9 labelers **\$210.50** Each

10+ labelers **\$206.00** Each

1155® Introductory Pack

All you need to get started. Call for details.

1155® Ink Rollers



One ink roller included with every labeler.

\$7.60 Per Roller

Black **12077801**
OUTDOOR™ Black **12406801**
See page 25 for additional details.

Select from one of the models shown below to meet your marking needs. Each illustrates a different arrangement of print bands.

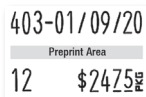

Model **1155-01**
prints in 24 positions

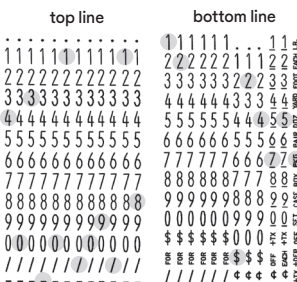

Model **1155-02**
1234-678 340
Preprint Area
123 \$12.95

prints in 24 positions

Model **1155-03**
14/20 568
Preprint Area
\$105.00

prints in 24 positions

Model **1155-06**
4231 \$10.99
Preprint Area
2/12 \$18.00

prints in 24 positions

Other models available. Call for details.

Monarch® 1155® Labels

Slightly larger than Monarch® 1142® Labels, Monarch® 1155® Labels provide more real estate to convey information that is important to your customers or relevant to your employees. The larger format lends to easier reading and grabs your customers' attention.



Fluorescent labels are brighter than shown here.

FT – General-Purpose Adhesive RT – Removable Adhesive

1155® Labels



Price Per Sleeve

Quantity	Stock	Custom
1-3	\$52.80	\$83.68
4-5	\$44.96	\$69.20
6-7	\$40.88	\$62.08
8-11	\$39.52	\$53.52
12-15	\$34.64	\$48.56
16	\$32.80	\$46.56

1155® Labels Standard Packaging

Labels Per Roll 1,000
Labels Per Sleeve 8,000
Rolls Per Sleeve 8
Sleeves Per Case 16
Labels Per Case 128,000

PLUS - One black ink roller included with each sleeve.

Monarch® 1155® Labels compatible with the 1170® Labeler.

Monarch® Custom Labels See page 5 for easy ordering.

Durable OUTDOOR™ Labels

Custom labels available.

Call for details. OUTDOOR™ ink roller included with each sleeve. 5,000 labels per sleeve.

Weather-resistant, durable OUTDOOR™ labels with all-temperature adhesive suitable for most outdoor environments and exposure to some chemicals.

FTK-100 (900995)

625 labels/roll,
8 rolls/sleeve,
5M labels/sleeve,
16 sleeves/case,
80M labels/case

Price Per Sleeve

1-3	4-7	8-11	12-15	16
\$68.05	\$51.90	\$45.45	\$42.95	\$39.25



Rainbow Pack

\$52.80 Per Pack **900994**

One roll of each color, two rolls of fluorescent red. Total 8,000 labels.



Shop Monarch® handheld labelers and labels at averydennison.com/shopmonarch

Monarch® 1156® Promotional Labeler



The Monarch® 1156®'s large, bold print on large format fluorescent labels gets noticed! Its seven positions (two more than the 1138® Promotional Labeler) enable you to print multiple prices, including "2-for" pricing along with underscored cents symbol.

\$154.00 Each

1-4 labelers

5-9 labelers **\$145.50** Each

10+ labelers **\$126.25** Each



1156® Ink Rollers



Call for higher quantity price breaks.

One ink roller included with every labeler.

\$7.60 Per Roller

Black **12077801**
OUTDOOR™ Black **12406801**

See page 25 for additional details.

Select from one of the models shown below to meet your marking needs. Each illustrates a different arrangement of print bands.

Model 1156-01



prints in 7 positions

Model 1156-02



prints in 7 positions

Model 1156-03



prints in 7 positions

Retailing Tip

Labels with your name or logo remind customers where they shopped so they're more likely to return. Our custom printed labels help you advertise in or out of your store.

Monarch® 1156® Labels

Monarch® 1156® labels are the same size as our Monarch® 1155® labels but designed for a one line application using variable print. Larger variable text size brings more attention to the promotion or sale.



FT-708 (900980)
RT-701 (900981)



Fluorescent Pink
FT-712 (900982)
RT-705 (900983)



Fluorescent Green
FT-713 (900988)



Fluorescent Pink
FT-990 (900990)



Fluorescent Orange
FT-991 (900991)

Fluorescent labels are brighter than shown here.



FT-710 (900986)



FT-709 (900985)

1156® Labels



Price Per Sleeve

Quantity	Stock	Custom
1-3	\$52.80	\$83.68
4-5	\$44.96	\$69.20
6-7	\$40.88	\$62.08
8-11	\$39.52	\$53.52
12-15	\$34.64	\$48.56
16	\$32.80	\$46.56

1156® Labels Standard Packaging

Labels Per Roll 1,000
Labels Per Sleeve 8,000
Rolls Per Sleeve 8
Sleeves Per Case 16
Labels Per Case 128,000

PLUS - One black ink roller included with each sleeve.

Monarch® Custom Labels

See page 5 for easy ordering.

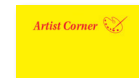

Durable OUTDOOR™ Labels

Weather-resistant, durable OUTDOOR™ labels with all-temperature adhesive suitable for most outdoor environments and exposure to some chemicals.

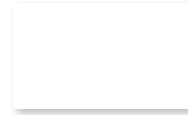

FTK-100 (900995)

625 labels/roll,
8 rolls/sleeve,
5M labels/sleeve,
16 sleeves/case,
80M labels/case

Custom labels available. Call for details. OUTDOOR™ ink roller included with each sleeve. 5,000 labels per sleeve.

Price Per Sleeve

1-3	4-7	8-11	12-15	16
\$68.05	\$51.90	\$45.45	\$42.95	\$39.25



Rainbow Pack

\$52.80 Per Pack **900994**

One roll of each color, two rolls of fluorescent red. Total 8,000 labels.



Shop Monarch® handheld labelers and labels at
averydennison.com/shopmonarch

Monarch® 1153® 3 Line Labeler



With large format printing and large labels, the Monarch® 1153® can pack plenty of information onto every item.

With this 36-position (12 characters per line) labeler, you'll enjoy a huge variety of options for managing your inventory - it's ideal for controlling shipping and receiving as well as recording serial numbers in your stockroom and on the selling floor.

\$296.50 Each
1-4 labelers



5-9 labelers **\$263.25** Each
10+ labelers **\$240.50** Each

PLUS - One ink roller included with every labeler.

Select from one of the models shown below to meet your marking needs. Each illustrates a different arrangement of print bands.

Visit our website for details on these models.

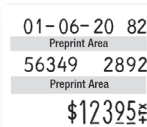

Model 1153-01
prints in up to 36 positions

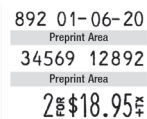

Model 1153-03
prints in up to 36 positions

AT
BU
CV
DW
EX
FY
GZ
HI
J2
K3
L4
M5
N6
P7
Q8
R9
S0



Model 1153-02
prints in up to 36 positions

The 12 middle line bands are print-around bands with the letters A-Z (except I and O) and the numbers 1-0

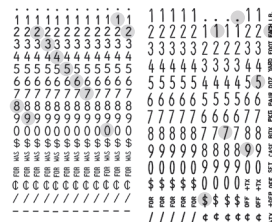

Monarch® 1153® Labels

Offering 3 lines of variable print, Monarch® 1153® labels are easy to read large format labels used for inventory management to note employee and item codes, comparison pricing and more.



FZ-802 (000281)
RZ-801 (000280)



FZ-804 (900656)
RZ-803 (000282)



FZ-812 (000283)



RZ-806 (000285)

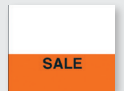

PZGC-808 (000270)

FZ - General-Purpose Adhesive
RZ - Removable Adhesive

Fluorescent labels are brighter than shown here.

1153® Labels



Price Per Sleeve

Quantity	Stock	Custom
1-3	\$52.86	\$83.64
4-5	\$44.94	\$69.12
6-7	\$40.86	\$62.04
8-9	\$39.36	\$55.74
10-15	\$34.56	\$50.52
16	\$32.70	\$46.50

1153® Labels Standard Packaging

Labels Per Roll: 1,000
Labels Per Sleeve: 6,000
Rolls Per Sleeve: 6
Sleeves Per Case: 16
Labels Per Case: 96,000

PLUS - One black ink roller included with each sleeve.

Monarch® Custom Labels

See page 5 for easy ordering.

1153® Ink Rollers



One ink roller included with every labeler.

\$7.60 Per Roller

Black **12077801**

See page 25 for additional details.

1153® Introductory Pack

All you need to get started. Call for details.



Monarch® Labeling Accessories

All-Purpose Holster

This highly durable all-purpose holster has four pockets so you can use it for your scrapers, tag attachers and safety cutters in addition to your labeler.



All-Purpose Holster
\$16.50 Each 954144

2" x 42" Polypro Adjustable Belt
\$8.50 Each 954145



Vinyl Holster

For one-line labelers.

Vinyl Holster
\$11.50 Each 000940



Stainless Steel Clip

Keep your labeler close with a stainless steel clip that hangs from a belt or waistband. Holds 1130® and 1150® series labelers.

Stainless Steel Clip
\$8.00 Each 954233M



Labeler Belt Clip



This durable plastic clip easily slides over your pants or belt and is designed to hold Monarch® 1130® and 1150® series labelers.

Labeler Belt Clip
\$7.50 Each 954233

Plastic Monarch® Label Scraper

This Monarch® Plastic Label Scraper is made of durable plastic to remove labels quickly and easily.



Monarch® Label Scraper
\$8.50 Pack of 10 M00PLS01

Steel Tip Scraper

This Steel Tip Scraper is made of heavy-duty steel and includes a cover. With a bright orange handle it's easy to spot.



Steel Tip Scraper
\$8.25 Bag of 4 900415

Keep your print crisp and clean!

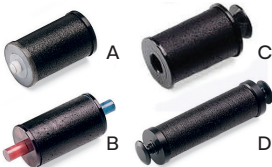

Ink Rollers

Additional ink rollers available. See picture and key for the one that's right for your labeler.

	Labelers	Order	Color	Use Indoor	Use Outdoor	Price
A	1103, 1105, 1107, 1110	08394601	Black	x	x	\$5.95
		08394606	Red	x	x	
		08394604	Green	x	x	
B	1115	08968801	Black	x	x	\$7.60
C	1130, 1131, 1135, 1136	11828001	Black	x	x	
		11828006	Red	x	x	
D	1142, 115X, 116X, 117X, 1185	11962401	Black	x		
		12077801	Black		x	
		12406801	Black		x	

Each labeler comes with a standard black indoor ink roller, and each sleeve comes with either an indoor or outdoor black ink roller to match the supply.



Shop Monarch® ink rollers at averydennison.com/inkrollers



Keep your 1110® Labelers operating smoothly!

1110® Maintenance Kit

Kit contains:

1. One ½ oz. bottle of silicone lubricant
2. One label removal strip
3. Six ink roller carriers
4. Six ink roller covers
5. Six door latches
6. Two ink rollers and operating instructions



SAVE OVER \$91.00

For the Monarch® 1110® Labeler

\$45.00 Per Kit 119919

Total Value - Over \$136.85

Tagging Tools and Supplies Index

Softlines Tagging

Fine Fabric	Page
Tagging	27
Standard	Page
Tagging	28
Hanging	28
Pairing	28

Hard Goods

Standard	Page
Hanging	29
Loop Tagging	29
Heavy Duty	Page
Pairing	30
Bundling	30

Specialty Tagging

Outdoor / Horticulture	Page
Tagging	31
Black weather-resistant	31
Food	Page
Food tagging: Fish, Meat, Poultry	32
Food Grade Nylon Tagging	32
Easy-to-clean Attacher	32

Choose your strength

Application

Lightweight	Standard Use	Heavy Duty	Industrial
Fine Fabric Formals Swimwear Doll Accessories Quilt Tacking	Blue Jeans Purses, Hats, Socks Housewares Sporting Goods Toys	Towels Rugs Shoes Horticulture	Tools Automotive Security Food

Fastener material

Lightweight		Standard Use		Heavy Duty			Industrial
Polypropylene				Nylon			
Mico	Tagger Hook	Poly. Paddle	Loop Fasteners	T-end	Nylon Paddle	Display-It Hooks	Double Paddle

Product type

Lightweight	Standard Use	Heavy Duty				Industrial
Polyester	Polypropylene	Nylon				
StringTach	Secur-a-tach	Secur-a-tie	Ladder-style Ties	Shoe Tie	Cable Tie	Cable Tie

Length

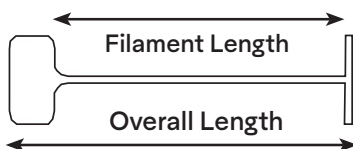

Nominal Filament Length: The actual working length of the fastener, not including the paddle or the tail. **Nominal Overall Length –** The length of the fastener.

Hint - If you require your product tags to hang 1" off the product, add 1" to the thickness of your product. Choose the Nominal Filament Length to accommodate this length.

Hint - If you have a bundle of socks measuring 2", the product that accommodates this packaging falls in the Nominal Filament Length: 2".

All fasteners are manufactured to exact industry specifications regardless of origin. Color variations, although rare, may occur from one run to another.

Softlines Tagging: Fine Fabrics Fastener Solutions

Swiftach® Mark V™ Fine Fabric Fastening System



**Anvil Guard
Tag Holder Guard**
Interchangeable with
Tag Holder Guard



Note: each needle includes needle cover.

1-4 **\$28.75** Each
5+ **\$27.00** Each
11501™



'No Touch' Needle Safety Feature:

The Anvil Guard – the ultimate in operator protection throughout the supply chain. The design eliminates the need for opposing finger pressure behind the garment when tagging.

The Tag Holder Guard – a retractable needle design and finger guides ensure reduced exposure to the needle tip when applying opposing pressure during tagging. Ideal for tagging seams in multiple areas of a garment.



Swiftach® Fine Fabric Long Plastic Base Needle
11503™



Swiftach® Fine Fabric Long Heavy-Duty Needle
11504™

Mark V® Hand Tool Needles

Order	Description	Pkg Qty.	Price Per Each	
			1-4	5+
Needles				
11503™	Swiftach® Fine Fabric Long Plastic Base Needle	4/Kit	\$15.00	\$14.25
11504™	Swiftach® Fine Fabric Long Heavy-Duty Needle*	4/Kit	\$24.00	\$23.25

Mark V Accessories

11506™	Mark V® Needle Cover – Fine Fabric	10/Bag	\$1.00	\$0.95
--------	------------------------------------	--------	--------	--------

*Use with Mark V® only.

Swiftach® Fine Fabric Soft Grip® Attacher

Attach tags on silk, linen and more. The soft, non-slip cushion comfort grip is molded into the handle and trigger to provide a firm grip while tagging.



1-4 **\$35.50** Each
5+ **\$30.50** Each
M0SGF-01



SG Replacement Fine Needle

Order	Description	Qty./Pkg.	Price
954889	White plastic base	4	\$13.25
118201	All steel	4	\$25.35



All needles are compatible with Monarch® 3025 Tag Attacher.

118201

Swiftach® Mark III™ Fine Fabric Attacher

The industry standard for delicate fastening applications. It's perfect for tagging silk, satin, lycra, linen, nylon, rayon, elastic, polyester, infant wear, microfiber and more. The tool's ergonomic design with easy-squeeze mechanism makes it the number one choice for tagging applications.



1-4 **\$28.50** Each
5+ **\$27.00** Each
954888



Mark III™ Pistol Replacement

Order	Description	Qty./Pkg.	Price
954889	White plastic base	4	\$13.25
954890	All steel heavy-duty	4	\$17.25



Fine profile designed for delicate fabrics. Effective length 0.344" (4mm). All steel needles for multiple layer applications.

954889

Avery Dennison Brand Fasteners

Fine Fabric Paddle Fasteners



T-End Natural Color Fine Fabric Fasteners (nylon)



Nominal Overall Length (in/mm)	Nominal Filament Length (in/mm)	Fasteners Per Clip	Qty./Pkg.	Filament	Nominal Applied Strength (lbs./Kg)	Order	Price Per Package		
							1-4	5-9	10
1.9-2.1"/49-53mm	1.8"/45mm	50	5M	Poly**	2.8lbs./1.27Kg	08939	\$23.25	\$21.00	\$14.50
0.9-1.0"/23-26mm	0.75"/19mm	50	5M	Nylon	3.5lbs./1.58Kg	000968	\$23.25	\$21.00	\$14.50
0.9-1.1"/23-27mm	0.75"/19mm	50	5M	Nylon	2.8lbs./1.27Kg	10453-0AD*	\$23.25	\$21.00	\$14.50
							Price Per Package		
0.7-0.9"/19-23mm	0.67"/17mm	100*	10M	Poly**	2.8lbs./1.27Kg	10343-0AD	\$45.50	\$42.00	\$28.00
2.0"/50.8mm	1.7"/44mm	100*	10M	Poly**	2.8lbs./1.27Kg	955101	\$45.50	\$42.00	\$28.00
2.9-3.1"/74-78mm	2.8"/70mm	100*	10M	Poly**	2.8lbs./1.27Kg	954432	\$45.50	\$42.00	\$28.00

All fasteners are natural in color except item 10453-0AD which is white nylon. **Polypropylene *100 - Clip not compatible with Scissor grip.

Nominal Overall Length (in/mm)	Nominal Filament Length (in/mm)	Fasteners Per Clip	Qty./Pkg.	Filament	Nominal Applied Strength (lbs./Kg)	Order	Price Per Package		
							1-4	5-9	10
0.50"/13mm	0.44"/11mm	50	10M	Nylon	3.5lbs./1.58Kg	10689-0AD	\$49.00	\$44.50	\$31.50



For higher quantity price breaks, call: 1-800-543-6650 Monday-Friday 8am-7pm EST

Softlines Tagging: Standard Fastener Solutions

Swiftach® Mark V™ Standard Fastening System



Note: each needle includes needle cover.



Swiftach® Standard Needle 11502™



Tag Holder Guard
Interchangeable with Anvil Guard

BUY MORE + SAVE

1-4 **\$28.75** Each
5+ **\$27.00** Each
11500™

Mark V® Hand Tools

Order	Description	Pkg Qty.	Price Per Each	
			1-4	5+

Needles

11502™	Swiftach® Standard Needle	4/Kit	\$15.00	\$14.25
--------	---------------------------	-------	---------	---------

Mark V Accessories

11505™	Mark V® Needle Cover – Standard	10/Bag	\$1.00	\$0.95
--------	---------------------------------	--------	--------	--------

Swiftach® Mark III™ Standard Attacher

Ideal for tagging knit shirts, lightweight to medium-weight fabrics.

1-4 **\$27.75** Each
5+ **\$26.00** Each
954885

BUY MORE + SAVE



Mark III™ Pistol Replacement Needles

Order	Description	Qty./Pkg.	Price
954886	Short plastic base	4	\$13.25
954887	All steel heavy-duty	4	\$18.95



All steel is preferred for most heavy-duty applications.

954887

Swiftach® Standard Soft Grip® Attacher

Attach tags on knit and cotton fabrics. The soft, non-slip cushion comfort grip is molded into the handle and trigger to provide a firm grip while tagging.

Switch to heavy-duty needle (117802) to tag rugs, wool and upholstery



BUY MORE + SAVE

1-4 **\$35.50** Each
5+ **\$30.50** Each
M0SGR-01

SG Replacement Regular Needle

Order	Description	Qty./Pkg.	Price
954886	Black plastic base	4	\$13.25
118202	All steel	4	\$21.20
117802	All steel heavy-duty	3	\$19.00



All needles are compatible with Swiftach® Standard Soft Grip® Attacher and Monarch® 3020 Tag Attacher.

954886

Non-Branded Standard Fasteners



Size	Per Clip	Color	Nominal Applied Strength	Order
1/2"	50	Red	3.6 lbs.	954713
1/2"	50	Black	3.6 lbs.	954718
1/2"	50	Green	3.6 lbs.	954717
1/2"	50	Blue	3.6 lbs.	954714
1/2"	50	Yellow	3.6 lbs.	954715
1/2"	50	Orange	3.6 lbs.	954960
1"	50	Red	3.6 lbs.	000111
1"	50	Black	3.6 lbs.	000112
1"	50	Green	3.6 lbs.	000113
1"	50	Blue	3.6 lbs.	000114
1"	50	Yellow	3.6 lbs.	000115
1"	50	Pink	3.6 lbs.	900260
1"	50	Dark Pink	3.6 lbs.	954876
1"	50	Orange	3.6 lbs.	900261
1"	50	Gray	3.6 lbs.	954462
1"	50	Lilac	3.6 lbs.	954498
3"	50	Red	3.6 lbs.	000123
3"	50	Black	3.6 lbs.	000124
3"	50	Green	3.6 lbs.	000125
3"	50	Blue	3.6 lbs.	000126
3"	50	Yellow	3.6 lbs.	000127
3"	50	Pink	3.6 lbs.	900257
3"	50	Dark Pink	3.6 lbs.	954877
3"	50	Orange	3.6 lbs.	900256

Price Per Package*			
1-4	5-9	10-19	20+
\$24.75	\$22.25	\$15.25	\$11.00

* Quantity: 5,000 per package

Standard Paddle Swiftach



Nominal Overall Length (in/mm)	Nominal Filament Length (in/mm)	Fasteners Per Clip	Qty./Pkg.	Filament	Nominal Applied Strength (lbs./Kg)	Order	Price Per Package		
							1-4	5-9	10
0.8-0.9"/19.0-23mm	0.60"/15mm	50	5M	Poly**	3.6lbs./1.63Kg	000902	\$23.25	\$21.00	\$14.50
1.0-1.1"/24-28mm	0.75"/19mm	50	5M	Poly**	3.6lbs./1.63Kg	955106	\$23.25	\$21.00	\$14.50
1.1-1.3"/29-33mm	1.0"/25mm	50	5M	Poly**	3.6lbs./1.63Kg	11018-0AD	\$23.25	\$21.00	\$14.50
1.2-1.3"/29-33mm	1.0"/25mm	100	10M	Poly**	3.6lbs./1.63Kg	954778	\$45.50	\$28.00	\$20.00
1.9-2.1"/50-53mm	1.8"/46mm	50	5M	Poly**	3.6lbs./1.63Kg	08035-0AD	\$23.25	\$21.00	\$14.50
2.2-2.3"/55-59mm	2.0"/50mm	100	10M	Poly**	3.6lbs./1.63Kg	10658-0AD	\$45.50	\$28.00	\$20.00
2.7-2.9"/69-73mm	2.6"/65mm	50	5M	Poly**	3.6lbs./1.63Kg	000994	\$23.25	\$21.00	\$14.50
3.1-3.3"/80-84mm	3.0"/75mm	100	10M	Poly**	3.6lbs./1.63Kg	954780	\$45.50	\$28.00	\$20.00
0.7-0.9"/19-23mm	0.6"/15mm	50	5M	Nylon	5.6lbs./2.54Kg	954605*	\$24.75	\$22.25	\$15.75
0.79-0.83"/20-21mm	0.6"/15mm	100	10M	Nylon	5.6lbs./2.54Kg	11077-0AD*	\$49.50	\$31.50	\$29.50
1.0-1.1"/24-28mm	0.75"/19mm	50	5M	Nylon	5.6lbs./2.54Kg	954604*	\$24.75	\$22.25	\$15.75
1.18-1.22"/30-31mm	1.0"/25mm	100	10M	Nylon	5.6lbs./2.54Kg	954955*	\$49.50	\$31.50	\$29.50
2.7-2.9"/69-73mm	2.6"/65mm	50	5M	Nylon	5.6lbs./2.54Kg	955107*	\$24.75	\$22.25	\$15.75
5.1-5.2"/129-133mm	5"/125mm	50	5M	Nylon	5.6lbs./2.54Kg	08961-0AD*	\$27.25	\$23.75	\$16.25

*Heavy-Duty **Polypropylene

Standard T-End Swiftach (nylon)



Nominal Overall Length (in/mm)	Nominal Filament Length (in/mm)	Fasteners Per Clip	Qty./Pkg.	Nominal Applied Strength (lbs./Kg)	Order	Price Per Package			
						1	2-9	10-19	20+
0.49"/12.4mm	0.4"/10mm	100	5M	5.6lbs./2.54Kg	955108*				
0.8-0.9"/20-22mm	0.7"/17mm	100	5M	5.6lbs./2.54Kg	10704-0AD*				
0.9-1.1"/24-28mm	0.9"/23mm	100	5M	5.6lbs./2.54Kg	954900	\$25.00	\$22.50	\$20.00	\$17.50
0.9-1.1"/24-28mm	0.9"/23mm	100	5M	5.6lbs./2.54Kg	954901**				
1.1-1.2"/28-30mm	1.0"/25mm	100	5M	5.6lbs./2.54Kg	10703-0AD*				
5.2-5.4"/133-137mm	5.0"/132mm	50	5M	5.6lbs./2.54Kg	955109	\$54.75	\$45.75	\$43.75	\$42.25
9.1-9.3"/232-236mm	9.0"/231mm	50	5M	5.6lbs./2.54Kg	954968	\$59.75	\$50.75	\$48.75	\$47.25

*Longer clip/standard pitch **Not connected

Hard Goods: Standard Fastener Solutions

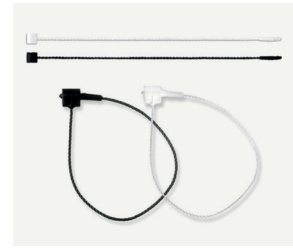

Secur-a-tach® is a security tie fastener that locks into a fixed length creating a loop that can be used to hang items as well as attach tags and labels to them.

StringTach™ is a security tie fastener that locks into a fixed length and creates a loop that can be used to hang items as well as attach tags and labels to them, this hand-applied fastener is made of polyester thread and is often used with softer, more elegant items you may not want to pierce.

Secur-a-tach® (polypropylene)

Nominal Overall Length (in/mm)	Qty. Per Pkg.	Color	Strength (lbs./Kg)	Order	Price Per Thousand		
					5M	25M	50M+
3.3"/85mm	5,000	Natural	8lbs./3.6Kg	000937	\$10.55	\$9.95	\$9.25
5.3"/135mm	5,000	Natural	10lbs./4.5Kg	000938	\$10.55	\$9.95	\$9.25
9.3"/235mm	5,000	Natural	8lbs./3.6Kg	000939	\$11.00	\$10.30	\$9.55

StringTach™ (textile string)

Nominal Overall Length (in/mm)	Qty. Per Pkg.	Color	Strength (lbs./Kg)	Order	Price Per Pkg.
					4
5.0"/125mm	100	Black	6.0lbs./2.74Kg	954904	\$4.25
7.9"/200mm	100	White	6.0lbs./2.74Kg	954905	\$5.25

Secur-a-tach and StringTach are hand-applied fasteners ideal for items when piercing material is not an option.

Display-It Hooks

Designed to work with Avery Dennison attacher tools and T-End Fasteners, these handy hooks enable retailers to hang merchandise vertically for increased product visibility and maximum space efficiency.

Display hook 1.75" long
2,000 per package.



Swiftach® V-Tool Attacher



By applying loop-fastened tags to hard goods like belts, sporting goods, sunglasses, kitchen utensils and more, the V-Tool can permanently end the tedium of having to do it by hand.

V-Tool Fasteners (nylon)

Nominal Overall Length (in/mm)	Nominal Filament Length (in/mm)	Per Clip	Color	Order	Price Per Pkg.
					5M
2.5"/64mm	2.5"/64mm	50	Black	954937	\$5.40
3"/76.2mm	3"/76.2mm	50	Natural	954938	\$5.15
5"/127mm	5"/127mm	50	Natural	954940	\$5.25

Standard Hooks (polypropylene)



Nominal Overall Length (in/mm)	Nominal Filament Length (in/mm)	Fasteners Per Clip	Qty./Pkg.	Nominal Applied Strength (lbs./Kg)	Order	Price Per Package			
						1-4	5-9	10-19	20+
1.8-1.9"/45-49mm	1.0"/25mm	50	5M	3.6lbs./1.63Kg	000918	\$39.25	\$35.50	\$33.50	\$28.75
2.2-2.3"/55-59mm	1.4"/35mm	50	5M	3.6lbs./1.63Kg	000919	\$39.25	\$35.50	\$33.50	\$28.75

Heavy-Duty Hooks (nylon)



Nominal Overall Length (in/mm)	Nominal Filament Length (in/mm)	Fasteners Per Clip	Qty./Pkg.	Nominal Applied Strength (lbs./Kg)	Order	Price Per Package			
						1-4	5-9	10-19	20+
1.8-1.9"/45-49mm	1.0"/25mm	50	5M	5.6lbs./2.54Kg	954963	\$39.25	\$35.50	\$33.50	\$28.75

Standard Loops (nylon)



Nominal Overall Length (in/mm)	Nominal Filament Length (in/mm)	Fasteners Per Clip	Qty./Pkg.	Nominal Applied Strength (lbs./Kg)	Order	Price Per Package			
						1-4	5-9	10-19	20+
1.5-1.7"/38-44mm	1.5"/38mm	25	5M	5.6lbs./2.54Kg	900341	\$45.00	\$43.75	\$42.50	\$41.25
2.7-2.8"/67-71mm	2.6"/65mm	25	5M	5.6lbs./2.54Kg	900342	\$45.00	\$43.75	\$42.50	\$41.25



Hard Goods: Heavy Duty Fastener Solutions

Fastening Tools and Supplies

Hand applied fasteners help you secure, gather and tag bulky merchandise. Shoe Tie, Secur-a-tie®, StringTach™, Secur-a-tach® and Cable Tie fasteners are long-lasting and strong.

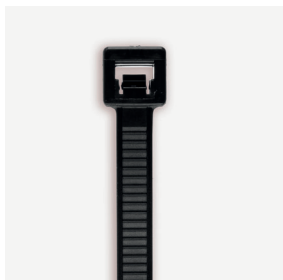

Cable Tie pulls to desired tightness.

Cable Ties

Description	Size	Nominal Applied Strength	Color	Qty. Per Bag	Order	Price Per Bag	
						1-4	5+
Cable Tie	4"	18 lbs.	Natural	1,000	954516	\$10.95	\$10.50
Cable Tie	5.5"	40 lbs.	Natural	1,000	954959	\$18.95	\$14.95
Cable Tie	7.5"	50 lbs.	Natural	1,000	954649	\$28.95	\$25.95
Cable Tie	8"	18 lbs.	Natural	100	954647	\$2.95	\$2.75
Cable Tie	7.4"	50 lbs.	Natural	100	954231*	\$3.65	\$3.65
Cable Tie	11"	50 lbs.	Natural	100	954232	\$7.25	\$7.25
Cable Tie	15"	50 lbs.	Natural	100	954652	\$9.50	\$8.50
Cable Tie	14.5"	50 lbs.	Natural	500	954651	\$44.25	\$40.00
Cable Tie	34"	175 lbs.	Natural	50	954913	\$24.25	\$24.25
Cable Tie	8"	18 lbs.	Black	100	954648*	\$3.45	\$3.05
Cable Tie	7.5"	50 lbs.	Black	100	954530*	\$6.29	\$5.59

*Weather-resistant

Tightening cable ties is a cinch with our Cable Tie Tool

Reduce labor and fatigue with this lightweight, manual cable tie installation tool. Simply insert the tie into the tool and squeeze until the cable is tightened and neatly cut to the desired length.



\$38.50 954911



Shop more Swiftech® fastening solutions at averydennison.com/swiftech

Ladder-Style Ties



Secur-a-tie® tightens into place.

Secur-a-tie® (nylon)

Nominal Overall Length (in/mm)	Qty. Per Pkg.	Color	Strength (lbs./Kg)	Order	Price Per Thousand		
					5M	25M	50M+
5.0"/127mm	5,000	Natural	15lbs./6.8Kg	000936	\$10.95	\$10.85	\$10.55

Consolidate, group and pair merchandise

Easy-Latch Barrel Design!

Shoe Tie connects products that come in groups or pairs.

Additional Shoe Tie sizes available. Call for details.



Cable Ties

Description	Size	Nominal Applied Strength	Color	Qty. Per Bag	Order	Price Per Bag	
						1-4	5+
Shoe Tie	11"	40 lbs.	Natural	1,000	954373	\$53.00	\$49.00



BUY MORE
SAVE

Ladder-Style Ties

Nominal Overall Length (in/mm)	Qty. Per Pkg.	Color	Strength (lbs./Kg)	Order	Price Per Pkg.	
					1-4	5+
7"/177.8mm	1,000	Natural	40lbs./18.14Kg	954933	\$32.20	\$28.80
7"/177.8mm	1,000	Black	40lbs./18.14Kg	955104*	\$32.70	\$29.20
11"/279.4mm	1,000	Natural	40lbs./18.14Kg	955113	\$45.00	\$41.00
11"/279.4mm	1,000	Black	40lbs./18.14Kg	954964*	\$46.00	\$42.00

*Heat stabilized

Specialty Attacher Applications: Fastener Solutions

Swiftach® Mark III™ Horticultural Attacher

With needles made of corrosion-resistant stainless steel and featuring drain holes for easy cleaning, this uniquely designed attacher with heavy-duty needles meets the needs of the horticultural industry.



1-4 **\$38.50** Each
5+ **\$37.00** Each
954897



Mark III™ Horticultural Tool Replacement Needles

Order	Description	Qty./Pkg.	Price
954887	Heavy-Duty All Steel Needle	4	\$18.95
954894	Heavy-Duty Stainless Steel Needle	4	\$26.50



BUY MORE + SAVE

Nominal Overall Length (in/mm)	Nominal Filament Length (in/mm)	Qty. Per Pkg.	Per Clip	Color	Applied Strength (lbs./Kg)	Order	Price Per Package			
							1	2-9	10-19	20+
0.9-1.1"/24-28mm	0.9"/23mm	5,000	100	Natural	5.6 lbs./2.54Kg	954900 Connected 954901 Not Connected	\$25.00	\$22.50	\$20.00	\$17.50

Swiftach® Mark III™ Long Needle Attacher

Featuring extra long needles, this Avery Dennison Mark III™ attacher is ideal for tagging thick or bulky merchandise like towels, duvet covers, rugs, multiple layers of wool and more.



1-4 **\$38.75** Each
5+ **\$37.00** Each
954891

Mark III™ Long Needle Replacement Needles

Order	Description	Qty./Pkg.	Price
954892	Heavy-Duty Long Version All Steel	4	\$32.50

Avery Dennison Fasteners – See pages 27-28.

Swiftach® MicroTach™ Attacher

Replace thread, staples and pins with the Swiftach® MicroTach™ Attacher, which applies short, discreet nylon tags that hold fast and apply easily. It's ideal for packaging dress shirts without the use of metal pins, securing lightweight items within displays and tag attaching for delicate retail goods.



MicroTach™ Tool
\$34.00 Each 954872

Replacement Needles

Order	Description	Qty./Pkg.	Price
954873	Short Shaft, Plastic Base Needles	4	\$25.35



954873

MicroTach™ Fasteners

Nominal Overall Length (in/mm)	Nominal Filament Length (in/mm)	Qty. Per Pkg.	Per Clip	Color	Nominal Applied Strength (lbs./Kg)	Order	Price Per Package			
							1-4	5-9	10-49	50+
0.212"/5.4mm	0.17"/4.4mm	10,000	120	Nylon White	2.0lbs./0.91Kg	954874	\$49.00	\$44.50	\$31.50	\$23.50
0.212"/5.4mm	0.17"/4.4mm	10,000	120	Nylon Black	2.0lbs./0.91Kg	954875	\$49.00	\$44.50	\$31.50	\$23.50

BUY MORE + SAVE

Specialty: Food Fastener Solutions

Swiftach® Mark III® Tag Fast™ Attacher

With needles made of corrosion-resistant stainless steel and featuring drain holes for easy cleaning, this tool is designed for food industry use such as tagging meat. Its double-paddle tags are extra strong and offer a firm grip for removal.



Mark III™
Tag Fast Attacher
1-4 **\$46.50** Each
5+ **\$36.00** Each
954893

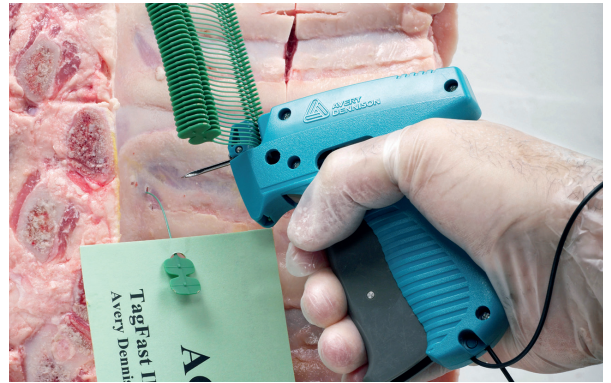

Mark III™ Tool Replacement Needles

Order	Description	Qty./Pkg.	Price
954894	Heavy-Duty Stainless Steel Needle	4	\$26.50



954894

Double-Paddle Regular Nylon Fasteners

Food Grade	Order	Price Per Package				
		1-4	5-9	10-24	25-49	50+
Blue	954895	\$11.25	\$9.95	\$8.50	\$7.25	\$6.50
Green	954896					



50 per clip. Order in multiples of 1,000.

Nominal applied strength: 10.0lbs./4.5Kg.
Nominal overall length (in/mm): 2.33"-2.7" / 59.5-68.5mm
Nominal filament length (in/mm): 1.77"-45mm

High volume solution

Swiftach® System 1000® Hand Attacher

Because each reel contains 1,000 fasteners, the Swiftach® System 1000® is well suited for tagging large volumes of inventory without reloading, and features a unique mechanism to help prevent jams. Ideal to attach tags to industrial packaging as well as apparel, the System 1000® easily operates between general purpose and heavy-duty applications.



BUY MORE
+
SAVE

1-4 **\$42.75** Each
5+ **\$41.75** Each
954906



System 1000® Replacement Needles

Order	Description	Qty./Pkg.	Price
954886	Black Plastic Base	4	\$13.25
954887	Heavy-Duty All Steel	4	\$18.95



954886



954887

System 1000® Roll of Fasteners (nylon) - Order in multiples of 5,000

Nominal Overall Length (in/mm)	Nominal Filament Length (in/mm)	Per Clip	Color	Applied Strength (lbs./Kg)	Order	Price Per Package*			
						1	2-9	10-19	20+
0.9-1.2"/ 24-30mm	0.87"/ 22mm	1,000	Red	4.0 lbs./ 1.8Kg	10315	\$27.50	\$25.00	\$22.50	\$20.00
			Dark Blue		10316	\$27.50	\$25.00	\$22.50	\$20.00
			Green		10317	\$27.50	\$25.00	\$22.50	\$20.00
			Yellow		10318	\$27.50	\$25.00	\$22.50	\$20.00
			Natural		954909	\$25.00	\$22.50	\$20.00	\$17.50
0.7-1.8"/ 43-46mm	1.5"/ 38mm	1,000	Natural	4.0 lbs./ 1.8Kg	954910	\$25.00	\$22.50	\$20.00	\$17.50

*5,000 per pack.

Coupon Tags

Perforated Garment Price Tags

Perfect for retailers not using barcode point of sale, these perforated tags are available in a variety of colors and allow retailers to retain a portion of the tag—with duplicate item-data included—for use in inventory management.



Box quantity: 1,000 tags

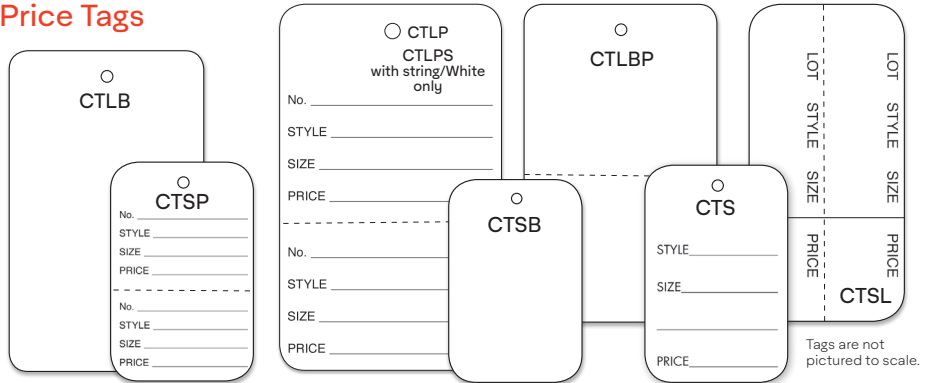

Tags are not pictured to scale.

	Printed Black 1 3/4" x 2 7/8" With Perf CTLP	Blank 1 3/4" x 2 7/8" No Perf CTLB	Blank 1 3/4" x 2 7/8" With Perf CTB	Printed Black 1 3/4" x 2 7/8" With Perf CTLP	Printed Black 1 1/4" x 1 7/8" With Perf CTSP	Printed Black 1 1/4" x 1 7/8" No Perf CTS	Blank 1 1/4" x 1 7/8" No Perf CTSB	Printed Black 1 3/4" x 2 7/8" Perf/ String CTPLS
White	000355	993211	993200	993266	953420	993231	993255	000141
Yellow	900080	993212	993201	993267	953421	993232	993256	-
Pink	900564	993213	993202	993268	993222	993233	993257	-
Purple	900561	993214	993203	993269	993223	993234	993258	-
Orange	900083	993215	993204	993270	993224	993235	993259	-
Gray	900559	993216	993205	993271	993225	993236	993260	-
Red	900562	993217	993206	993272	993226	993237	993261	-
Lt Green	900082	993218	993207	993273	993227	993238	993262	-
Lt Blue	900081	993219	993208	993274	993228	993239	993263	-
Buff	900560	993220	993209	993275	993229	993240	993264	-
Fl. Red	993186	993221	993210	993276	993230	993241	993265	-
Dk. Blue	900563	-	-	-	-	-	-	-

Qty.	Price Per Package							
1-2	\$15.70	\$15.70	\$15.70	\$15.70	\$13.70	\$13.70	\$13.70	\$18.85
3-4	\$14.65	\$14.65	\$14.65	\$14.65	\$12.65	\$12.65	\$12.65	\$17.90
5+	\$13.60	\$13.60	\$13.60	\$13.60	\$11.60	\$11.60	\$11.60	\$17.40

BUY MORE + SAVE

Custom Perforated Tags reinforce your brand identity!

Easy Ordering

- Specify tag size, quantity, type style (shown on right) and tag color (two-letter code). Tags will be printed in black ink.
- Specify wording, horizontal or vertical placement, and position of holes and perforations.
- Add your store logo if desired. Send digital artwork to: RIS.IPSSALES@averydennison.com

Add a one-time set-up charge of \$50.00 for each item ordered. No charge on future exact reorders if ordered within three years.

For a proof before printing, a \$20.00 service fee will be added. Order will be processed when proof is approved and returned to Avery Dennison.



- BIKE & HIKE
- CRAWFORD ANTIQUES
- GOIN' FISHIN'
- Diana's Petite Boutique
- Holiday Flowers & Gifts

Due to printing processes, actual color of tags may vary slightly from colors shown.

Size	With String Order	Price Per Thousand		Without String Order	Price Per Thousand	
		5M	10M		5M	10M
1 1/4" x 1 7/8"	GP-13---			GP-14---		
1 3/4" x 2 7/8"	GP-15---	\$44.00	\$39.25	GP-16---	\$39.00	\$35.00
1 3/8" x 2 3/4"	GP-17---			GP-18---		
2" x 2 7/8"	GP-21---	\$55.25	\$49.00	GP-22---	\$49.25	\$43.65

Merchandise Sizing Labels

Keep your merchandise organized with size labels! Size labels make it easy to find sizes and know your inventory at a glance. These size labels are available for sizes XX Small - XXX Large.

Strips.

Ideal for folded or unfolded apparel.

Custom size strips available, call for details. No mixing, one style per price.



Size/Description	5"x1 1/4" Strips 250 Per Roll	1/2" Sizing Circles 1,000 Per Roll	3/4" Sizing Circles 1,000 Per Roll
X-Small	969688	-	-
Small	969689	998267	998340
Medium	969690	998337	998341
Large	969691	998338	998342
X-Large	969692	998339	998343
XX-Large	969693	-	-
XXX-Large	969694	-	-
	Price Per Roll		
1-4	\$10.95	\$5.84	\$8.55
5-9	\$10.25	-	-
10-24	\$9.45	-	-
25+	\$8.45	-	-

Tags

Blank Tags enable unique handwritten charm

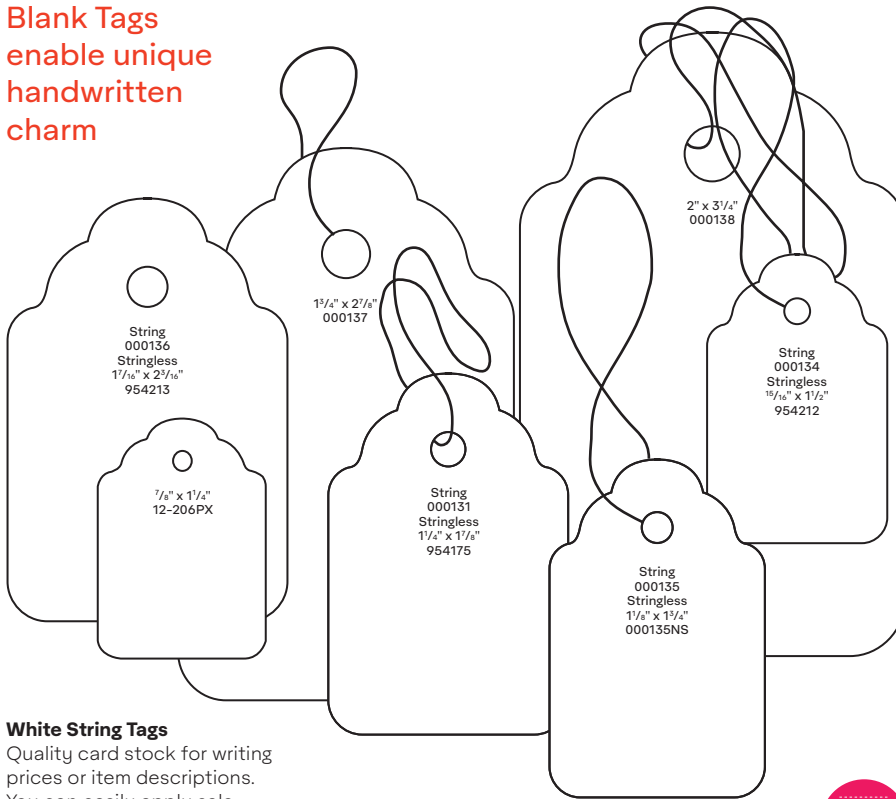

White String Tags

Quality card stock for writing prices or item descriptions. You can easily apply sale labels if desired (see our labelers, pgs. 7-24). White 5 1/2" looped strings.

Fluorescent Color String Tags

Grab customers attention and help you move merchandise! Use for color coding by discount level, size and more.

Stringless White Tags

Attach them with our tag attacher and plastic fasteners (pgs. 28-32).

Note: Dimensions may vary up to 1/8" due to manufacturing tolerances.

Fluorescent String Tags

1 1/8" x 1 3/4". White strings.



Order	Description	Price Per Thousand		
		1-2M	3-4M	5M+
12-206PX	Stringless, White	\$18.65	\$16.35	\$14.50
000134	String, White	\$22.30	\$19.50	\$17.35
954212	Stringless, White	\$13.50	\$12.75	\$12.25
000135	String, White	\$22.95	\$20.10	\$17.85
000135NS	Stringless, White	\$14.00	\$13.50	\$12.75
000131	String, White	\$28.00	\$24.50	\$21.75
954175	Stringless, White	\$14.90	\$13.50	\$12.75
000136	String, White	\$28.15	\$24.65	\$21.90
954213	Stringless, White	\$16.95	\$14.80	\$14.25
000137	String, White	\$32.25	\$28.20	\$25.10
000138	String, White	\$35.35	\$30.90	\$27.50
954124	String, Fl. Green	\$32.55	\$28.50	\$25.35
954125	String, Fl. Pink	\$32.55	\$28.50	\$25.35
954126	String, Fl. Chartreuse	\$32.55	\$28.50	\$25.35
954127	String, Fl. Red	\$32.55	\$28.50	\$25.35

BUY MORE
SAVE



Jewelry Labels and String Tags

Perfect for hard-to-mark merchandise. These tags are great for price marking on rings, necklaces, and small accessories and come in a variety of sizes and shapes. "Dumbbell" labels have adhesive only on the ends. Tags have burgundy, 3" looped string.

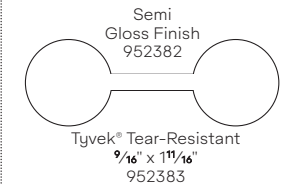
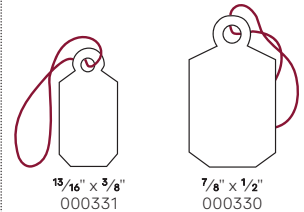

Order	Price Per Thousand
	1M
000330*	\$25.00
000331*	\$25.00
952382	\$15.00
952383	\$19.00

* Burgundy string

Red and Yellow Sale Tags

Bright, bold, promotional tags on 5 1/2" looped string.

BUY MORE
SAVE

Order	Size	Price Per Thousand		
		1-2M	3-4M	5M+
000130*	1 1/8" x 1 3/4"	\$14.50	\$13.95	\$13.50
000163*	1 5/8" x 2 3/4"	\$17.95	\$16.50	\$15.50
954297**	1 3/3" x 2 7/8"	\$19.95	\$18.50	\$17.95

* White String **Yellow String



000130

000163

954297

Tags and Labels

Imprinted or Plain, Large Merchandise Tags attract attention!

Bold, preprinted "Hold," "Sold" and "Sale Price" tags with a slit easily slip over merchandise. Or make your own message on plain manila tags, available in eight sizes or Tyvek® tags in three sizes, 1,000 per package.

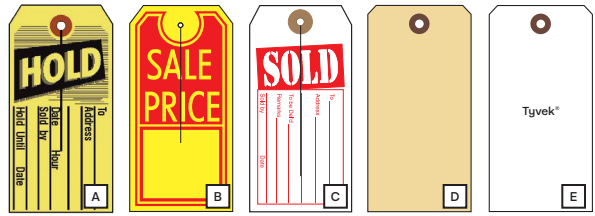

Code	Order	Size	Price Per Package	
			1	3
A	000122	2 ³ / ₈ " x 4 ³ / ₄ "	\$36.50	-
B	000167	2 ⁵ / ₈ " x 5 ¹ / ₄ "	\$36.50	-
C	000121	2 ³ / ₈ " x 4 ³ / ₄ "	\$36.50	-
D	954520	2 ³ / ₄ " x 1 ³ / ₈ "	\$9.50	\$8.50
D	954521	3 ¹ / ₄ " x 1 ⁵ / ₈ "	\$11.75	\$10.75
D	954522	3 ³ / ₄ " x 1 ⁷ / ₈ "	\$13.50	\$12.50
D	954523	4 ¹ / ₄ " x 2 ¹ / ₈ "	\$15.50	\$14.50
D	954524	4 ³ / ₄ " x 2 ³ / ₈ "	\$18.25	\$16.75
D	954525	5 ¹ / ₄ " x 2 ⁵ / ₈ "	\$21.75	\$20.00
D	954537	5 ³ / ₄ " x 2 ⁷ / ₈ "	\$24.25	\$22.25
D	954527	6 ¹ / ₄ " x 3 ¹ / ₈ "	\$28.25	\$26.00
E	11-441PX	2 ³ / ₄ " x 1 ³ / ₈ "	\$41.00	\$38.00
E	11-442PX	3 ¹ / ₄ " x 1 ⁵ / ₈ "	\$48.50	\$45.00
E	11-445PX	4 ³ / ₄ " x 2 ³ / ₈ "	\$72.00	\$68.00
E	11-449PX	2 ³ / ₈ " x 4 ³ / ₄ "	\$125.00	-

Standard Shipping Tags



Shop Standard Shipping Tags online at averydennison.com/tags for available size and color options.

Wire Bundles

12" long, 26 gauge, 1,000 per package.



\$8.95 Per pack 954256

General-Purpose Adhesive Labels

Custom general purpose labels available in yellow, fluorescent red and white only.

- General-purpose adhesive adheres to most surfaces
- Can only be removed with some effort

Order	Qty. Per Package	Price Per Package				
		1	2-4	5-9	10-19	20+
000041	12M	\$166.80	\$159.60	\$106.20	\$86.64	\$77.28
000042	10M	\$157.40	\$150.50	\$122.60	\$85.80	\$67.50
000044	6M	\$106.32	\$100.56	\$74.82	\$56.82	\$45.60
000045	6M	\$110.82	\$103.44	\$80.16	\$64.56	\$55.80
000052	8M	\$125.44	\$119.76	\$86.08	\$70.80	\$59.28

RC-75 (000041)
prints 3 lines
7 characters ea.
3/4" x 1/4"

RC-76 (000042)
prints 3 lines
9 characters ea.
1/4" x 11/16"

RC-78 (000044)
prints 4 lines
9 characters ea.
11/16" x 11/16"

RC-79 (000045)
prints 4 lines
10 characters ea.
11/16" x 1 1/32"

RC-178 (000052)
prints 3 lines
10 characters ea.
3/4" x 1 1/32"

Custom Products



Call 1-800-543-6650 for pricing.

Attacher Tags

Available in a variety of shapes and colors, with perforations between each tag.

Order	Qty. Per Package	Price Per Package			
		2-11	12-23	24-47	48+
000373	2M	\$49.20	\$39.94	\$31.22	\$28.32
000374	2M	\$52.74	\$41.58	\$32.58	\$31.22
000381	2M	\$56.82	\$45.68	\$35.56	\$33.52
000384	2M	\$43.08	\$34.36	\$23.84	\$20.86
000385	2M	\$53.68	\$43.32	\$33.02	\$30.68

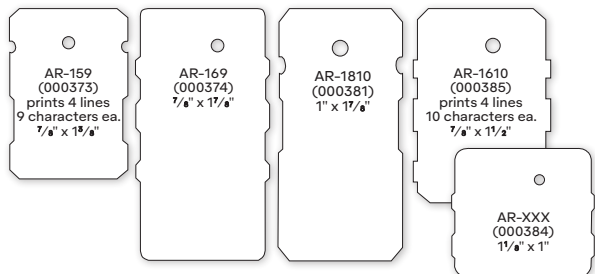

Colors for Attacher Tags

Stock attacher tags above are available only in white*.

Choose tag or label color.

Choose ink color for custom print.



+ Shop plain and colored shipping tags online at averydennison.com/tags

Register forms

Capture all transaction details!

Nine styles designed to help you record sales transactions accurately. No messy carbons. Carbonless copies are clear and easy to read.

FREE! Four-line imprint and stock logo added at no extra charge.



Photo Key	4" x 6 1/2"		5 3/8" x 8 1/2"	
	2-part	3-part	2-part	3-part
A	NC-2401	NC-3401	NC-2501	NC-3501
B	NC-2408	NC-3408	NC-2504	NC-3504
C	-	-	NC-2802	NC-3802
D	NC-2403	-	-	-
E	NC-2406	NC-3406	-	-
F	-	-	NC-2502	NC-3502
G	-	-	NC-2510	NC-3510
H	NC-2407	NC-3407	NC-2507	NC-3507
I	NC-2526	NC-3526	NC-2525	NC-3525
	Total Price		Total Price	
250	\$40.00	\$47.50	\$50.00	\$65.00
500	\$65.00	\$70.00	\$75.00	\$95.00
1,000	\$85.00	\$100.00	\$110.00	\$150.00
2,000	\$110.00	\$160.00	\$150.00	\$220.00

Bonus!

Register sent with every order.

Steps to Order:

1. Specify start number for consecutive numbering. (if not specified, your forms will be produced without numbering.)
2. Select imprint color: Red, Blue, Green or Black.
3. Specify imprint. Provide exact words, maximum of six lines.
4. Specify body imprint if desired. Add any wording you want in the body of your register forms. Maximum of six lines in imprint color selected in Step two (Red, Blue, Green or Black). Add \$10.00.
5. Specify type style. (If type style is not specified, your forms will be imprinted with #1)

- 1 GATEWAY ELECTRICAL
- 2 *St. Louis Sporting Goods*
- 3 **Whitney Pharmacy**
- 4 **DAYTON CONCRETE**
- 5 *Old English*
- 6 **BIKE & HIKE**

6. Add your own logo for a one-time fee of \$30.00 (No charge on future reorders within three years). Provide digital artwork in an acceptable format such as JPEG, EPS or TIFF with resolution no less than 300 dpi. Art department will proof and approve all artwork.
SAVE postage. E-mail artwork to RIS.IPSSALES@averydennison.com
7. Select a FREE stock logo. Available on all register forms and most other forms. Call toll-free 1-800-543-6650 for details about additional stock logos not shown.

FREE proof on first orders. Minimum charge for additional proofs.

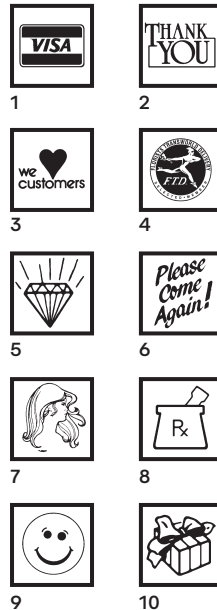

A CASH/CHARGE

E DRUGSTORE

H GENERAL-PURPOSE

B APPAREL

C FLORIST

D CREDIT MEMO

F AUTOMOTIVE/PARTS

G SPECIAL RETAIL

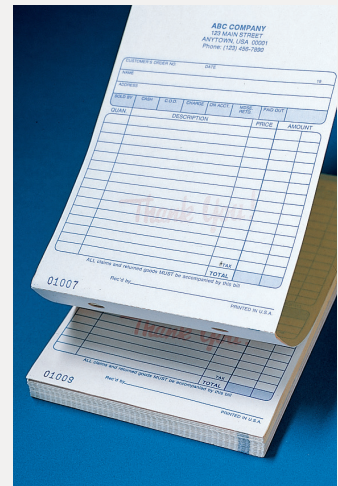

I DESIGNER/CASH/CHARGE

Registers

Register machines provide a hard surface for writing and deliver a non-stop supply of multi-part forms in one operation. All the parts in a set are perfectly aligned because of the machines' registration features.

- A. Durable Plastic Register
- B. Heavy-Duty Metal Register

Key	Order	Description	Form Size	Holding Capacity		
				2-part	3-part	Price
A	949006	Plastic	4" x 6" or 6 1/2"	160	110	\$42.95
B	949625*	Metal	4" x 6" or 6 1/2"	250	160	\$155.95
B	949626*	Metal	5 3/8" to 6 1/2" x 8 1/2"	250	160	\$162.95

*Features a pop-out drawer, thumb ejector and non-skid rubber feet.

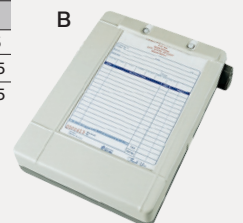

Forms and Certificates

Register Form Books

Bound books for orderly records. All styles include 50 sets of forms per book.

Free Imprint

Include your business name and address, up to four lines of information. Printed in block print with black ink.

Each book contains 50 forms consecutively numbered from 1-50 or from any starting number you choose.

Each book within your order will have the same sequence of numbers from one book to the next.

Stay on top of your orders

4 1/2" x 7"		
	2-part	3-part
	FSB-1542	FSB-1543
	Total Price	
10	\$109.50	\$139.50
15	\$142.50	\$187.50
25	\$223.75	\$262.50
50	\$347.50	\$425.00

5 1/2" x 8"		
	2-part	3-part
	FSB-1532	FSB-1533
	Total Price	
10	\$139.50	\$149.50
15	\$187.50	\$194.25
25	\$262.50	\$298.75
50	\$425.00	\$547.50

BUY MORE + SAVE

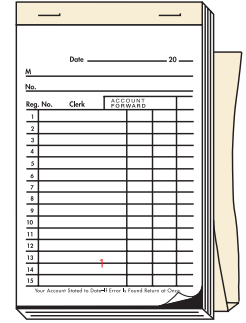
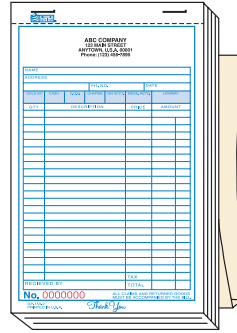

BUY MORE + SAVE

To customize your books for an additional charge, call: 1-800-543-6650

Example: First book 1-50, second book 51-100, third book 101-150, etc. Call for details.

3 3/8" x 5 1/8" two part **900533**
"No-Name" Carbon No imprint!
Each package includes 100 books.

Order	Price Per Package		
	1-2	3-4	5
900533	\$81.95	\$70.95	\$65.95

Invitation Size Silver Embossed Gift Certificates

Project a first-class image. The brilliant silver foil-stamped certificate on heavy card stock with matching envelope will be one your customers will be proud to give. Each certificate features a detachable receipt stub for your accurate record keeping.

- Each certificate is 4 3/8" x 5 3/4"
- Consecutively numbered
- Imprinted with up to 4 lines of block print (black ink)



BUY MORE + SAVE

Order	Total Price		
	100	250	500
FSL-52-GY	\$185.00	\$387.50	\$725.00



FREE counter announcement with each order

Register Forms

Carbonless snap-apart forms are clean and easy to use. Ideal for invoices, sales slips, receipts and more! Simply snap out copies when completed.

Use how-to-order instructions on page 36 (exception: four-line imprint will be in black ink).

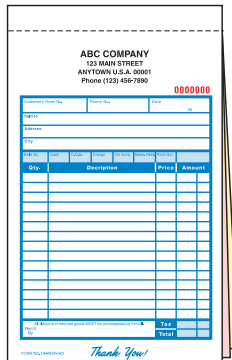

BUY MORE + SAVE

	4 1/2" x 7"	
	2-part	3-part
	MSF-273	MSF-274
	Total Price	
250	\$52.50	\$60.00
500	\$75.00	\$95.00
1,000	\$98.00	\$143.00
2,000	\$160.00	\$240.00

	5 1/2" x 8"	
	2-part	3-part
	MSF-383	MSF-384
	Total Price	
250	\$62.50	\$80.00
500	\$100.00	\$135.00
1,000	\$150.00	\$250.00
2,000	\$260.00	\$360.00

Snap-Apart Certificates

These two part, mess-free, carbonless, check-sized gift certificates are consecutively numbered, easy to snap-apart and ideal for record keeping. Each certificate includes a FREE matching presentation envelope.

- Each certificate is 3 1/2" x 7 3/4"
- FREE Imprint with up to four lines of print in black ink



BUY MORE + SAVE

Order	Description	Total Prices		
		100	250	500
FSL-788-BL	Blue	\$37.00	\$70.00	\$115.00
FSL-788-GN	Green			
FSL-788-OG	Orange			
FSL-788-RD	Red			

Shelf Labels and Promotional Signage



Works with inkjet or laser printers.

Create bar code, mailing, shipping or promotional labels and more!

*These are not Avery labels.

Key	Order	Description	Length x Height	Labels Per Sheet	Sheets Per Pack	Price Per Pack		
						1	3	5+
A	979880	Address	2 ⁵ / ₈ " x 1"	30	100	\$30.00	\$26.00	\$21.00
A	993313	Address Fl. Green	2 ⁵ / ₈ " x 1"	30	100	\$39.00	\$35.00	\$29.00
A	993314	Address Fl. Red	2 ⁵ / ₈ " x 1"	30	100	\$39.00	\$35.00	\$29.00
B	979882	Address	4" x 1"	20	100	\$30.00	\$26.00	\$21.00
C	979886	Shipping/Address	4 ¹ / ₄ " x 2 ³ / ₄ "	8	100	\$30.00	\$26.00	\$21.00
D	979888	Shipping/Address	4" x 2"	10	100	\$30.00	\$26.00	\$21.00
D	993303	Address Fl. Green	4" x 2"	10	100	\$39.00	\$35.00	\$29.00
D	993304	Address Fl. Red	4" x 2"	10	100	\$39.00	\$35.00	\$29.00
E	979889	Shipping	8 ¹ / ₂ " x 5 ¹ / ₂ "	2	100	\$30.00	\$26.00	\$21.00
F	992825	Price Marking	1" x 1"	80	100	\$30.00	\$26.00	\$21.00
G	992826*	Price Marking	1" x 1"	80	100	\$30.00	\$26.00	\$21.00
H	993292	Circle	1"	63	100	\$30.00	\$26.00	\$21.00

BUY MORE & SAVE

* Features security slits.

Note: Not for use in applicators.

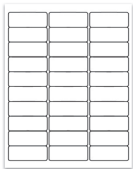

A

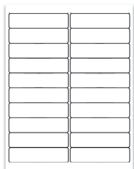

B



C

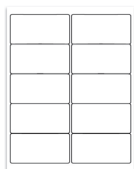

D



E

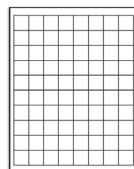

F

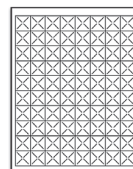

G

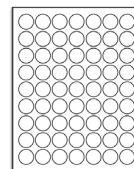

H

Print your own promotional shelf flags on your laser printer and have the flexibility to change or add promotions on the fly. Shelf-Talkers are bright yellow with a strip of adhesive across the top. Designed to hang below the regular price shelf tag and stick out slightly to grab customers' attention. Case contains 4 packs of 250 sheets.

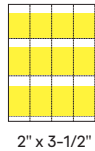

2" x 3-1/2"

Order	Description	Sheets Per Case	Price Per Case
F000002358	12-up White/Yellow	1,000	\$268.26

BUY MORE & SAVE

Promotional Sign Cards

Sheets of boldly printed and brightly colored signs designed to print on laser or inkjet printers. Made of sturdy lightweight card stock with a large print area, these cards are ideal to create your own message or promotion.

Key	Size	Cards Per Pack	Price Per Pack		
			1	2-4	5+
A	3 ¹ / ₂ " x 5 ¹ / ₂ "	400	\$20.75	\$18.75	\$16.50
B	5 ¹ / ₂ " x 7"	200	\$20.75	\$18.75	\$16.50
C	7" x 11"	100	\$20.75	\$18.75	\$16.50

BUY MORE & SAVE



A 989303
B 989313
C 989323



A 993983
B 993979
C 993975



A 979847
B 979857
C 979867

Promotional Stick on Starbursts

Vibrant colors for high impact sales messaging.

- Large 6" x 10¹/₂" die-cut starburst with peel off backing
- Stick on shelves, product and more
- Each package contains 25 Starbursts



954178



954179



954180

Order	Description	Price Per Pack
954178	Bright Yellow	\$6.95
954179	Magenta	\$6.95
954180	Bright Green	\$6.95

Stick on Flags

Draw attention to featured items to increase impulse sales.

- Adhesive sticks securely but comes off clean
- Vinyl weight - 10 mil
- Sticks to shelves, pegboard, signpost and more
- Each package contains 25 stick-on flags of one design
- Over 14 designs available. Call for details



954195



954799

Order	Description	Message	Size	Price Per Pack
954195	Arrow Flags	NEW	2" x 4 ¹ / ₂ "	\$2.99
954799	Square Flags	CLEARANCE	2 ³ / ₈ " x 3 ¹ / ₈ "	\$2.99

Merchandising Bags

BUY MORE + SAVE

Kraft Paper Bags

You will love the look and feel of these crisp, bright paper bags. Choose from a variety of sizes in stylish colors, Kraft and prints. The two largest sizes (12" x 3" x 18" and 14" x 3" x 21") have side gussets that expand.



Description	6 1/4" x 9 1/4"	8 1/2" x 11"	12" x 15"
Natural Kraft	949813	949823	979960
1-2 Cases	\$29.00	\$45.00	\$63.00
3+ Cases	\$26.00	\$41.00	\$58.00
White Kraft	949816	949826	979961
1-2 Cases	\$36.00	\$56.00	\$78.75
3+ Cases	\$33.00	\$51.00	\$73.00
Color			
Wild Rose	949818	949828	979974
Black	949814	949824	979968
Blue	969123	969127	979969
Sunbright	969469	969473	979975
Forest Green	969125	969129	979970
Cream	969124	969128	992739
Red	995051	995052	995053
Price Per Case			
Qty. Per Case	1,000	1,000	1,000
1-2 Cases	\$49.00	\$71.00	\$117.00
3+ Cases	\$45.00	\$65.00	\$107.00

Description	12" x 3" x 18"	14" x 3" x 21"
Price Per Case*		
Natural Kraft	949843	979963
1 Case	\$65.00	\$84.00
2-5 Cases	\$51.50	\$66.00
6+ Cases	\$49.50	\$61.50
White Kraft	949846	979964
1 Case	\$81.25	\$105.00
2-5 Cases	\$64.50	\$83.00
6+ Cases	\$62.00	\$77.50
Color		
Wild R e	949848	979983
Black	949844	979977
Blue	969131	979978
Sunbright	969477	979984
Forest Green	969133	979979
Cream	969132	992742
Red	995054	995055
Price Per Case*		
1 Case	\$99.00	\$125.00
2-5 Cases	\$91.00	\$122.50
6+ Cases	\$84.50	\$112.00

*Quantity 500 Per Case

Quality Kraft Shopping Bags

Package larger or multiple items with style and charm. Professional touches like these have a big impact on your customers.

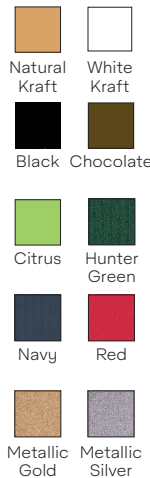

Pack Quantity	5 1/4" x 3 1/2" x 8 1/4"	8" x 4 3/4" x 10 1/2"	16" x 6" x 12"
	100	100	100
Natural Kraft	997767	997768	997769
1-5 Cases	\$31.00	\$34.00	\$36.00
6+ Cases	\$29.00	\$32.00	\$34.00
White Kraft	997771	997772	997773
1-5 Cases	\$34.00	\$36.00	\$41.00
6+ Cases	\$32.00	\$34.00	\$39.00
Color Tint Kraft			
Black	997779	997786	997793
Chocolate	997780	997787	997794
Citrus	997781	997788	997795
Hunter Green	997782	997789	997796
Navy	997783	997790	997797
Red	997785	997792	997799
1-5 Cases	\$56.00	\$57.00	\$60.00
6+ Cases	\$54.00	\$55.00	\$58.00
Metallic Tint Kraft			
Metallic Gold	997808	997811	997814
Metallic Silver	997809	997812	997815
1-5 Cases	\$58.00	\$59.00	\$62.00
6+ Cases	\$56.00	\$57.00	\$60.00

Plastic "Thank You" Shopping Bags

Add personality and charm to your customers' shopping experience with plastic bags printed with the words "Thank You." Featuring gusseted sides and built-in handles, these bags are as strong as they are sweet.



Key	Description	Size	Mil	Qty.	Case		Price Per Case		
					Weight	Order	1-2	3-4	5+
T-Shirt/Carrier Bags*									
A	Thank You—Blue Print	12" x 7" x 22"	0.55	1,000/case	15 lbs	989345S	\$47.00	\$45.00	\$42.00
A	Plain White	12" x 7" x 22"	0.55	1,000/case	15 lbs	989346	\$46.00	\$44.00	\$42.00
Merchandise Bags									
B	Plain White	24" x 6" x 36"	0.80	300/case	60 lbs	989343DS	\$123.00	\$121.00	\$119.00

BUY MORE + SAVE

Merchandising Bags

Solid Color Carrier Bags

Strong plastic bags with built-in handles.

These bags offer color, convenience and utility for a huge variety of products. They're also tougher than other bags so durability won't be a problem.



Size	12" x 7 1/2" x 23"
Mil	0.6 mil
Case Weight	17 lbs
White	959284
Dark Blue	959282
Red	959287
Yellow	959283
Dark Green	969416
Teal	959285
Magenta	959286

Bags have side gussets

Qty. Per Case (1,000)	Price Per Case
1-2	\$80.00
3+	\$78.00



Bags on a Roll

- Clear bags on a roll
- Packaging for purchases or products on display
- Easy-tear perforations
- Come with twist ties for securing



Description	Size	Mil	Qty.	Order	Price Per Roll	
					1-5	6+
Clear	6 1/2" x 8"	0.75	2,000/roll	954820	\$31.00	\$29.00
Clear	10" x 14"	0.75	1,000/roll	954821	\$34.00	\$32.00
Clear	18" x 24"	1.10	250/roll	954822	\$34.00	\$32.00

Super Gloss Merchandise Bags

These bags take it up a notch by offering a classy, sophisticated touch for customers at the end of their shopping experience. Available in a variety of sizes and colors, they're made with strong, low density plastic so reinforced handles are unnecessary to retain ultimate durability.



Size	9" x 12"	12" x 15"	15" x 18" x 4**	20" x 20" x 5**	24" x 24" x 5**
Mil	1.25 mil	1.25 mil	1.25 mil	1.50 mil	1.50 mil
Case Weight	9 lbs	15 lbs	14 lbs	19 lbs	27 lbs
Clear	997382	997398	997414	997446	-
Purple	997390	997406	997422	997454	-
Red	997391	997407	997423	997455	997460
White	997393	997409	997425	997457	997462
Yellow	997394	997410	997426	997458	-
Navy	997389	997405	997421	997453	-
Dark Blue	997383	997399	997415	997447	-
Dark Green	997384	997400	997416	997448	997459
Citrus Green	997381	997397	997413	997445	-
Black	997379	997395	997411	997443	-
Teal	997392	997408	997424	997456	997461
Hot Pink	997387	997403	997419	997451	-

*Bags have side gussets

Qty. Per Case	Price Per Case				
	1,000	1,000	500	500	500
1-2 Cases	\$53.00	\$83.00	\$70.00	\$95.00	\$142.00
3+ Cases	\$48.00	\$76.00	\$63.00	\$92.00	\$136.00



For additional colors and for higher quantity price breaks, call: 1-800-543-6650 Monday-Friday 8am-7pm EST

Merchandising Bags



Super Satin® Ameritote® Reusable Bags

With the ability to carry up to 22 pounds and featuring a square bottom, there's not a whole lot these reusable—and 100% recyclable—bags can't carry. Their bold colors ensure some added pop and personality.

Size Mil	12" x 10" x 4"	16" x 15" x 6"	22" x 18" x 8"
Case Weight	2.25 6 lbs	2.25 12 lbs	2.25 15 lbs
Clear	997624	997632	997648
Purple	997625	997633	997649
Citrus Green	997626	997634	997650
Hot Pink	997629	997637	997653
Red	997631	997639	997655
Qty. Per Case	250	250	200
Price Per Case	\$40.00	\$66.00	\$80.00



Reusable Environmental Prints – 100% Recyclable

Made of 3.5-millimeter gauge material these reusable shopping bags can carry up to 22 pounds and feature a square bottom for maximum capacity. Their ornamental, environmentally-inspired prints ensure an added bit of personality.

Description	Case Weight	19-1/2" x 16" x 7"
Sunflower Marigold Yellow	23.5 lbs	997601
Environment Print	23.5 lbs	997604
Qty. Per Case		250
Price Per Case		\$103.00



Super Wave Ameritote® Reusable Bags

These reusable—and 100% recyclable—bags are ideal for merchandise and food containers. Their bold colors ensure some added pop and personality.

Size Mil	18" x 15" x 6"	22" x 18" x 8"
	2	2
Qty. Per Case	250	250
Clear Frosted	994258	994265
Price Per Case	\$65.00	\$95.00
Color	Call for details	
Price Per Case	\$65.00	\$95.00

Sidewalk Signage

Deluxe White Rolling Sidewalk Sign



- Two-sided swinging sign features six lines per side
- Includes 314 – four inch letters in black with red numbers and symbols
- Contains 22 large eight inch numbers in red and two red “SALE” signs both nine inches tall
- Featuring two wheels and a subtle pull handle, the sign can be rolled in and out of place
- Steel filled cross tubes provide weight and stability to sign; ballast port offers additional weight if filled with sand or water
- Corrugated plastic sign surface is 24” x 36”
- Overall dimensions of sign and frame are 30” W x 42” H
- Rust- and ding-proof technopolymer construction

\$219.75 Each
997830

Swinger Roadside Street Sign



- Features:
- Two-sided sign comes with 421 – five inch letters in black with red numbers and symbols
 - Steel filled cross tubes provide weight and stability to sign; ballast port offers additional weight if filled with sand or water
 - Next best thing to a billboard, the corrugated plastic sign surface is 3’ x 4’
 - Rust- and ding-proof technopolymer construction
 - Deflects winds up to 30 mph

\$349.50 Each
995171

Extra letter Kit
421 – five inch black letters, numbers and symbols
\$74.50 Per Kit 997322

Folding, Rolling, Quick Load A-frame Sign

- Features:
- Two-sided, folding, quick loading sign
 - Overall size 27” W x 47” H
 - Holds standard 24” W x 36” H x 4mm corrugated plastic sign panels
 - Perfect for custom graphics or changeable Message Board signs
 - Ready to use, no assembly
 - Rolls easily from either side on wide, oversized 3” wheels
 - Deflects winds up to 30 mph



Swinger® Sidewalk Signs

- Features:
- Internal steel support for stability in wind and rain
 - Heavy-duty polymer plastic
 - Up to seven lines on two sides
 - Overall size 32” W x 42” H
 - Message area 24” W x 36” H
 - Includes 314 – four inch black letters, red numbers and symbols

\$189.75 Each 969980



Item	Description	Includes	Price
998457	A-plus Ready 4 Graphics Sign Holder* (Black)		\$179.50
998458	A-plus Standard Message Board Sign (White)	Set of 314 – 4” letters, numbers and symbols	\$225.50
998459	A-plus Standard Message Board Sign (Black)	Set of 314 – 4” letters, numbers and symbols	\$225.50
998460	A-plus Deluxe Message Board Sign (White)	Set of 314 – 4” letters, numbers and symbols. Set of 22 – 8” numbers with % plus two 9” reversible “SALE/Special” headers	\$235.50
998461	A-plus Deluxe Message Board Sign (Black)	Set of 314 – 4” letters, numbers and symbols. Set of 22 – 8” numbers with % plus two 9” reversible “SALE/Special” headers	\$235.50

Deluxe Extra Letter Kit

Don't forget an extra letter kit for use on your A Frame or Sidewalk Sign.

Deluxe, Extra Letter Kit Includes:

\$54.95 Per Kit 997318

- White background
- Eight inch Headings – red “Sale/Special”
- 314 – four inch black letters, red numbers and symbols

+ Shop more sidewalk signs at averydennison.com/signs

Security

Wireless Motion Detector and Annunciator



Wireless Annunciator Kit
\$139.95 Each 969998

Extra Chime for
 Wireless Annunciator
\$64.00 Each 994870

Extra "Motion Detector"
\$75.95 Each 997983

This easy-to-install device announces arrivals and exits with a pleasant two-tone chime. It boasts a transmitting range of over 500 feet and is not affected by wind, shadows, heat or temperature fluctuations. The volume is adjustable.

- Features:
- Plug-in remote receiver
 - Battery operated (9 Volt battery not included)
 - One year battery life in most circumstances
 - Supports multiple transmitters and receivers (customer dependent)

Electric Motion Detector



Announces arrivals and exits with a pleasant chime. It operates on a 16.5 Volt plug-in charger and includes 50 feet of wiring. Best of all, this device isn't affected by sunlight, headlights, reflections, shadows or other color variations.

- Supports up to two extra chimes

Electric Motion Detector
\$91.00 954517

Extra Chimes
\$25.00 954519

Battery Powered Motion Detector

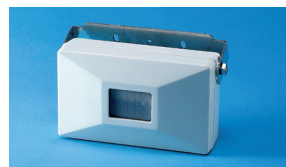

This easy-to-install device announces arrivals and exits with a pleasant chime. It's powered by a single 9 Volt battery (not included) and requires no wiring whatsoever.

- Easy, Low-Cost Deterrent!
- Supports up to two extra chimes

Battery Powered
 Motion Detector
\$46.00 954518

Shoplifting Prevention Ink Tag Pins with Backing Lock and Detacher

This offering is a complete set-up for retailers without an alarming shoplifting prevention system.

- Specifications:
- Package Includes: 1,000 Shoplifting Prevention Ink Tag Pins with backing lock and detacher

\$702.79 998235



Universal Ink Tag (only) - 1000 per package

Package includes Universal Ink Pins only. These tags require a backing.

\$365.84 998236

Magnetic Door Alert



Announces entries and exits with a pleasant chime.

- Plug-in receiver
- Transmission range of up to 100 feet
- Battery operated (6 Volt battery included)
- Self-contained announcer attaches to door frame
- Chime activates on doors that swing in one direction only

Magnetic Door Alert
\$44.95 Each 997984

Wireless Entrance Alert



Two-part wireless system includes transmitter and chime receiver.

- Easy-to-install transmitter with magnet attaches to door frame
- Chime receiver plugs into a standard wall outlet - up to 100 feet from the transmitter
- Transmitter requires a 6 Volt battery (included)

Wireless Entrance Alert
\$54.95 Each 997985

Mini Tag



This ALL-TAG Mini Security Tag is perhaps the most widely used Radio-Frequency (RF) tag for protecting clothing and softer goods. Package includes 1,000 Mini Tags with pin.

- Compatible with any 8.2 MHz Shoplifting Prevention systems

Note: This offering is for retailers who don't already have a magnetic remover to take the tags off the clothing at the point of sale.

Mini Tag with Pin, Plus 1 Detacher/Remover

\$336.95 998231

Mini Tag with Pin - 1000

(Same as 998231 except no detacher) This offering is for retailers who do already have a magnetic remover to take the tags off the clothing at the point of sale.

\$269.56 998230

Counterfeit Pen



Catch counterfeit money with a simple swipe by using the marker on bills in a non-printed area. If the mark remains an amber color the bill is valid - simple as that.

- Effective on U.S. bills printed 1959 and later.

\$12.95 Pack of 3
 954152

\$49.95 Pack of 12
 954153

5+ Packs
\$47.95 Per Pack of 12

BUY MORE
 SAVE

Bi-Directional Battery Operated Display People Counter

The Display Counter is equipped with a screen that shows the current total count. This counter automatically separates the in and out counts, and displays them on the screen separately.



\$481.36 998234

+ Shop more ink tags and security solutions at
averydennison.com/security

Baskets

Shopping Baskets

Increase store sales with hand baskets! Custom baskets feature a large logo in an 8.6" x 3.5" space. Rack sign reflects the customization of the baskets.

Standard Shopping Hand Baskets:

- Dimensions 17" L x 12" W x 9" H
- Includes 20 baskets, rack and sign
- Custom – rack sign reflects the customization of the baskets

Large Shopping Hand Baskets:

- Dimensions: 19.4" L x 13.3" W x 10" H
- Includes 18 baskets, rack and sign
- Custom – rack sign reflects the customization of the baskets



Includes rack and sign



Mini baskets available, call for details.



Rolling shopping baskets with telescoping handle also available at averydennison.com/shopmonarch. Call for details.



Sturdy, comfortable handles
Fiberglass-filled nylon for strength: hand contoured grip

Thicker fins
Baskets stack high, so they are seen more, used more and never jam together

Stronger basket
Thicker walls: body of high impact polypropylene

Stronger corners
Cantilevered for extra strength

All hand baskets are made made from recycled plastic and manufactured in the USA.

Basket colors



* Plum not available for mini baskets

Size	Standard Baskets 17" x 12" x 9" 20 Per Pack	Large Baskets 19.4" x 13.3" x 10" 18 Per Pack
Color	Order	Order
Black	997875	997887
Dark Blue	997876	997888
Emerald Green	997877	997889
Grape	997878	997890
Gray	997879	997891
Medium Blue	997880	997892
Orange	997881	997893
Plum	997882	997894
Red	997883	997895
Tan	997884	997896
Teal	997885	997897
Yellow	997886	997898
Price Per Pack	\$245.00	\$270.00

Larger quantities and custom imprint available. Call for product details and pricing.



Three easy steps to order custom imprinted shopping baskets.

Call for quote.

Imprint Colors Choices:

Black, White, Blue, Red

1. Choose basket size/color.
2. Choose imprint ink color.
3. Provide the copy or logo you want printed on the baskets. Provide a digital file of your artwork in an acceptable format such as (JPEG, EPS, TIFF) with resolution no less than 300 dpi. Art Department will proof and approve all artwork.

Save postage.

E-mail artwork to: PSD.customerservice@averydennison.com

Label Applicators



Monarch® 1159® Label Applicator

Zip through repetitive promotional labeling. Ideal for fast-turning inventory, the 1159's pre-printed labels are big and bold and available in fluorescents to capture attention while communicating deals. Choose from a variety of stock preprints or call for custom.

Monarch® 1159® Labeler M0115901
 1-4 **\$60.25** Each
 5-9 **\$57.75** Each
 10+ **\$54.00** Each

Monarch® 1159® Applicator Labels

1,000 labels per roll.
 Fluorescent red.

**Bright Labels
 Grab Attention!**



FXOP-278 (900278)

1159® Labels Standard Packaging

Labels Per Roll: 1,000
 Labels Per Sleeve: 6,000
 Rolls Per Sleeve: 6
 Sleeves Per Case: 16
 Labels Per Case: 96,000

Price Per Sleeve

Quantity	Stock	Custom
1-3	\$52.86	\$83.64
4-5	\$44.94	\$69.12
6-7	\$40.86	\$62.04
8-9	\$39.36	\$55.74
10	\$34.56	\$50.52

SCOOTER® Label Applicators

Available in three different models, the Scooter® applies pre-printed labels from 1" round to 2 5/8" wide giving you plenty of options and territory to communicate everything from promotions to shipping labels. Perfect for high-volume or fast-turning labeling jobs.



Order	M0221101	M0221001	M0221501
Max. Label Width	1 1/8"	1 5/8"	2 5/8"
Min. Label Length	15/16"	15/16"	15/16"
Max. Outside Roll Diameter	3 1/4"	5"	5"
Inside Roll Diameter	1 1/4"	1-3"	1-3"
	\$28.50	\$33.25	\$40.00

EasyTouch™ Label Applicator

Edge detector automatically detects leading edge of label, providing accuracy in dispensing every time.

* Dispenses a variety of customizable, die-cut labels
 * Three models to choose from based on your labeling needs



Order	954141	954142	954143
Max. Label Width	1 3/16"	2"	3 3/4"
Min. Label Length	15/16"	15/16"	15/16"
Max. Outside Roll Diameter	3 1/2"	3 1/2"	3 1/2"
Inside Roll Diameter	1"	1"	1"
	\$108.00	\$113.00	\$115.00

Promotional Labels/Circle Labels



906015

906016

906013

903030

906017

903032

903033

906019

906020

903037

903038

903039

903040

903041

903042

903043

903044

903045

903046

906092

903054

903047

903048

903049

903058

1-4 rolls **\$8.35** Each
5-8 rolls **\$7.82** Each
9-23 rolls **\$7.30** Each

24-63 rolls **\$6.77** Each
64-127 rolls **\$6.25** Each

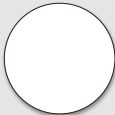

903024
White



903025
Fl. Red



903026
Fl. Orange



903027
Fl. Green



903029
Fl. Chartreuse



903028
Fl. Pink

Fluorescent Preprinted Labels

Bright, fluorescent red, 1³/₈" attention-getting preprinted circle labels grab your customers' attention. Size 1³/₈" circle – 1,000 labels per roll. May mix and match prints for quantity breaks.

Apply by hand or by applicator

Actual size
1³/₈"



900223

1 and 1³/₈" circles can be applied with SCOOTER® M0221001 or EasyTouch™ 954142



903000

903001

903003

903002

903004

903050

903005

Actual size
3/4"

903053
Red

903051

903052

903060

903061

903062

903064

903063

903070

903071

903072

903073

903074

903075

Actual size
1"

903006
Sale Price

903076

903080

903077

903078

903079

903081

903082

Solid Color and Percentage Off Circles

May mix and match same-size labels for quantity breaks.

Use color circles to color-code different price points, sizes, sale items, etc. You can even write information on them.

1,000 Labels Per Roll

Size	1-4	5-9	10+
3/4"	\$7.30	\$6.88	\$6.25
1"	\$7.30	\$6.88	\$6.25

PLEASE HANDLE WITH CARE

FRAGILE

THANK YOU

"FRAGILE" Label

Includes 500 – 2" x 3" labels per roll. Can be applied with SCOOTER® (page 46) M0221501 Label Applicator.

\$13.60 Per Roll 903059

Safety Cutters



EZ3® – Economical Utility Knife with Safety Spring-Back Blade

- Ambidextrous three-button design
- Universal right-or left-handed design: top power cut
- EZ Safety Point Blades
- Ergonomic body
- No tools needed for blade change
- Each knife includes one blade

\$99.75 Bag of 25
955165

Safety Point Quickblade Dispenser

- Non-stick blade dispensing lever
- Convenient, see-through body
- Built-in blade disposal slot
- 100 single-notch 0.017

\$25.15 Pack of 100
955164

For replacement blades, order either a handy Safety Blade Dispenser, number 955164, or the box of 100 blades, number 954868



Easy-Cut™ 4000 Safety Cutter

Eliminates product damage, reduces accidents and increases profits.

Simply set the dial to appropriate cardboard density – the engineered design of this cutter enables you to penetrate through cardboard without damaging the product inside.

- Precise blade depth setting for single, double and triple wall boxes
- Lock position for added safety
- Blade automatically retracts when it loses contact with the cutting surface, providing added protection to user
- Ergonomic handle and ambidextrous edge guides allow safe, accurate cutting
- Clip-on holster and lanyard (stretches up to six feet) offers convenient, safe storage and reduces cutter purchases



\$21.95 Each 955186



Blade Bank helps prevent injuries

Dispose of dangerous blades. Includes nylon straps, mounting bracket and screws.

\$13.95 Each 955192

Blades not included. Need blades? See page 48 item number 955164

Metal Case Cutters

\$11.00 Box of 12
000230

Replacement blades for above.

\$12.00 Box of 100
000233



The EasyCut™ Safety Cutting System

- Ergonomic with lever-activated cutting blade
- Fits both left-or right-handed users
- Three different blade depths
- Easy blade changes
- Extra blade storage in handle
- Swivel holster with safety lanyard
- On/off switch to activate automatic guide



\$10.95 Each

Blue 954844
White 954845
Yellow 954847
Orange 954846
Red 954848

Extra Blades blades for above.

\$30.00 Box of 81
954956



The Pocket Cutter™ protects before, during and after the cut!

- Concealed blade engages once trigger is squeezed
- Features blade vanishing technology, where the blade “vanishes” into the head of the knife when it’s no longer in contact with a cutting surface
- Disposable – no blade changes required
- Cuts material such as shrink wrap, nylon, plastic straps, cardboard and film
- Cuts up to 5,000 linear feet – three times longer than other disposable cutters



\$4.25 One Per Box 954975

\$11.95 3 Per Pack 954970

Replacement Blades

\$23.50 Box of 100
954868

Volume discounts on cutters - call for details

Workstations



Mobile Workstation

Ergonomically designed mobile workstation makes task like folding, markdowns, ticketing and inventory simpler and more efficient while increasing productivity. Includes a black textured powder coated frame, gray laminated wood top and four 4" casters. Additional accessories may be available.

Features:

- Gray wood work surface
- Dual folding leaves
- Adjustable storage bins
- Bottom shelf

\$359.00 Each 998453



Mobile Workstation Caddy

This 15" x 5" x 4" caddy attaches to the side of the Mobile Workstation, providing storage for tools, pens, sensor tags, etc. Also included is a sticker bar to hold promotional sticker rolls within easy access.

Features:

- Removable sticker bar
- Storage bin

\$59.00 Each 998454

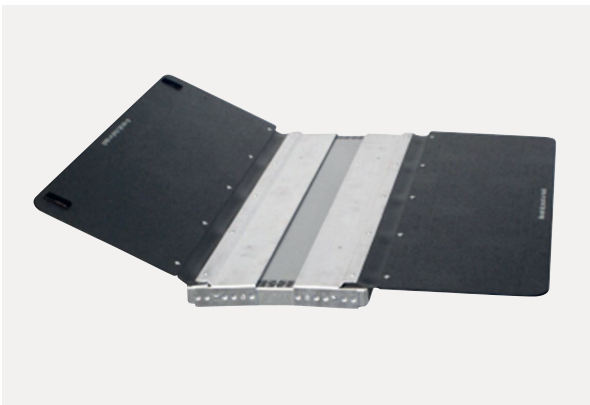

Tabletop Mobilefold Garment Folding Device

This lightweight, portable tabletop folding device can be used on top of a countertop, mobile workstation or utility cart. The tabletop folding device ensures consistent folds between 7 and 13 inches wide regardless of garment style.

Features:

- Adjustable center panel
- Lightweight aluminum frame
- Minimal storage

\$179.00 Each 998455



Nesting Work Table

Nesting work table designed to make tasks such as markdowns, ticketing, and inventory simpler and more efficient while increasing productivity. The work table has a black textured powder coated frame, gray laminated top and four 4" casters.

Features:

- 18" x 26" laminated work surface
- Bottom shelf
- Telescoping 4 directional hanger bar the folds up for storage and nesting

\$159.00 Each 998452

Terms and Conditions of Purchases

Subject to change or cancellation. Please periodically check our website for changes which may impact your order.

Limitation of liability.

Avery Dennison's total liability to Buyer and Buyer's exclusive remedy for direct damages, regardless of injury, death, property damage, or schedule delays, shall be limited to, at Avery Dennison's sole option, be a refund of purchase price paid or replacement of the product less a restocking or other applicable fees.

Avery Dennison shall not be liable to buyer for any consequential, incidental or special damages, regardless of the theory of law on which the claim is based. Warranty (Equipment and supplies).

All machines and equipment purchased from Avery Dennison are warranted in writing to be free from defects in materials and workmanship for one year from the date of manufacture. A specific warranty for each machine or equipment may be included in the shipping carton. Monarch® tags, labels and other supplies are warranted to be free from defects in material and workmanship for a period of ninety (90) days from date of manufacture and to operate with any properly functioning Monarch machine for which it was designed. The suitability of all purchased supplies for Buyer's application or usage is the sole responsibility of Buyer and Buyer should test such supplies in end-user conditions to ensure the supplies meet Buyer's requirements.

Avery Dennison does not warrant consistency, color of paper or ink in matching of typography for products imaged by Avery Dennison. This limited warranty is in lieu of any and all other warranties of representation expressed or implied, including merchantability or fitness for buyer's particular purposes.

Label supplies over/under run policy.

Items will be shipped within plus/minus approximately ten percent (10%) of order quantity, or to the nearest standard packaged unit or as otherwise agreed or published in corresponding product information.

Governing law.

This Agreement shall be governed and interpreted under the laws of the State of Ohio, without reference to its conflict of law rules.

Errors.

Identified in writing to Avery Dennison, such as typographic, descriptive or photographic errors are subject to correction and the cost associated with the correction may be charged to Buyer if the error was present in a proof-copy provided to Buyer and Buyer accepted the proof. Avery Dennison shall not be responsible for any errors which are the result of Buyer's submissions. This Agreement sets forth the sale terms and conditions between Avery Dennison and Buyer as well as those standard terms and conditions set forth on the applicable Avery Dennison website. The use of any purchase order, approval order, or any other instrument, form or agreement in connection with the services, deliverable or

products provided hereunder shall be considered for the convenience of the Buyer and any provisions therein shall not modify, supersede or supplement the terms and conditions of this.

Agreement custom orders.

Once set up for a custom order has been initiated, no custom order can be cancelled or modified and Buyer will be billed for cost of the order and any associated fees regardless of whether you accept delivery or not.

Pricing and availability.

Avery Dennison reserves the right to discontinue or adjust price of any product in this catalog. Items in this catalog are subject to availability of paper and other raw materials. Setup charges on custom orders are a one (1) time charge if reorder is made within three (3) years, from the original order date, excludes custom labels or changes in text or other description.

Minimum order required.

There is a minimum purchase requirement of \$50.00 for all orders.

Restocking fees.

Avery Dennison may charge a restocking fee equal to fifteen percent (15%) of the value of the order for standard products (e.g. no customization) or \$25 whichever is greater.

Billing terms.

Visa®, MasterCard® or American Express® accepted. Buyer payment to credit card holder is made pursuant to the card holder agreement. All items are F.O.B. shipping point. Appropriate state and local taxes, plus shipping rates and any other applicable fees will be added.

Shipping policy.

In-stock products typically ship in about two business days (or sooner if possible) from receipt of valid order. Please allow additional time for weekends and holidays. Custom Monarch machines typically ship in about four to six weeks depending on availability. Some products require separate shipments. Should this occur, it will be identified on your invoice statement. Avery Dennison shall not be responsible for delays or losses due to force majeure type events, such as fire, strikes, labor disputes, natural disasters, severe weather, terrorism, delay of carriers, and any other delays beyond Avery Dennison's control.

Acceptance/returns.

Failure of Buyer to object in writing within thirty (30) days of receipt concerning any defect or deficiency with the product received from Avery Dennison, constitutes complete acceptance by Buyer of shipment received. Avery Dennison reserves the right to recondition any rejected material to meet Buyer's specifications or to replace all or a portion thereof within a reasonable time after receipt by Avery Dennison. Product return requires prior authorization within thirty (30) days from date of shipment, no returns after thirty (30) days from date of shipment, and no returns for customized products.

Various third party trade names and trademarks are used herein and the property of their respective owner.

The information contained herein is believed to be reliable but Avery Dennison makes no representations concerning the accuracy or correctness of the data. The information and products in this guide, like any other should be confirmed independently for the particular end user conditions to ensure the proposed product, labeling or material meets the relevant requirements and regulations. Avery Dennison shall have no liability whatsoever, regardless of any legal theory, arising out of your use or reliance on the information contained herein. Independent results may vary.

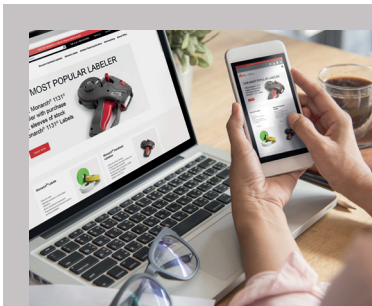

Sign up for our emails to receive:

- ✓ Valuable coupons
- ✓ Sales announcements
- ✓ Updates on our latest products

Visit: shopmonarch.averydennison.com/coupons

Special Offers

15% off Garment Products*

Perforated Garment Price Tags

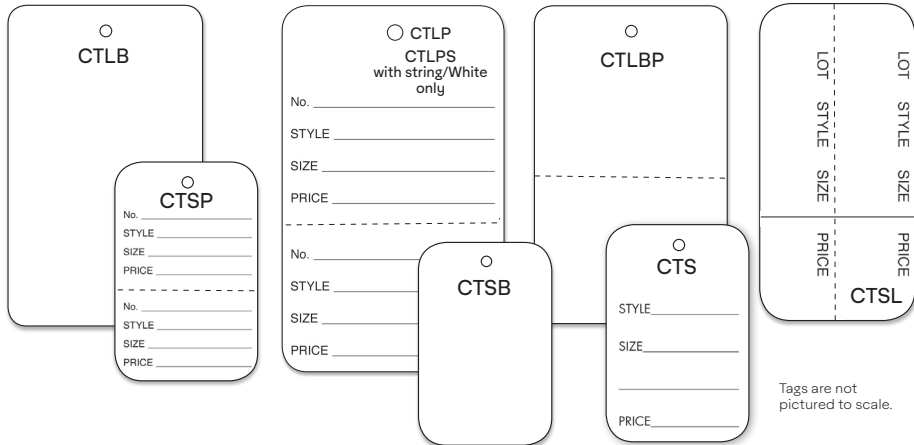

Tags are not pictured to scale.



Box quantity: 1,000 tags

1 3/4" x 2 7/8"		
Printed Black - With Perf CTLP		
Blank - No Perf CTLB		
Blank - With Perf CTLBP		
1 3/8" x 2 3/4"		
Printed Black - With Perf CTSL		
1-2	Regular Price	\$15.70
	Your Price	\$13.35
3-4	Regular Price	\$14.65
	Your Price	\$12.45
5+	Regular Price	\$13.60
	Your Price	\$11.56

1 1/4" x 1 7/8"		
Printed Black - With Perf CTSP		
Printed Black - No Perf CTS		
Blank - No Perf CTSPB		
1-2	Regular Price	\$13.70
	Your Price	\$11.65
3-4	Regular Price	\$12.65
	Your Price	\$10.75
5+	Regular Price	\$11.60
	Your Price	\$9.86

1 3/4" x 2 7/8"		
Printed Black - Perf/String CTLPS		
1-2	Regular Price	\$18.85
	Your Price	\$16.02
3-4	Regular Price	\$17.90
	Your Price	\$15.22
5+	Regular Price	\$17.40
	Your Price	\$14.79

*Offer not valid on custom items.

Merchandise Sizing Labels



SAVE 15%

5" x 1 1/4" - Strips - 250 Per Roll		
1-4	Regular Price	\$10.95
	Your Price	\$9.31
5-9	Regular Price	\$10.25
	Your Price	\$8.71
10-24	Regular Price	\$9.45
	Your Price	\$8.03
25+	Regular Price	\$8.45
	Your Price	\$7.18
1/2" - Sizing Circles - 1000 Per Roll		
1-4	Regular Price	\$5.84
	Your Price	\$4.96
3/4" - Sizing Circles - 1000 Per Roll		
1-4	Regular Price	\$8.55
	Your Price	\$7.27

Please see page 33 for Coupon Tags

Avery Dennison Printer Solutions Division
170 Monarch Ln
Miamisburg, OH 45342

**PRESORTED
STANDARD
U.S. POSTAGE
PAID
AVERY DENNISON**

For more effective service, please state the media code (right) when calling.



Free Shipping on your next order!

Shop online* at:
[averydennison.com/shopmonarch](https://www.averydennison.com/shopmonarch) and receive free shipping on an order of \$250 or more.

Coupon code: **FREE2020**

*Enjoy FREE SHIPPING on your purchase of Monarch Brand products with an order total of \$250 or more placed online at [averydennison.com/shopmonarch](https://www.averydennison.com/shopmonarch). Orders cannot be combined for free shipping. Not valid on phone orders. Use code FREE2020 at checkout. Visit our website for additional details. Offers valid until 5/7/2020



**SHOP
NOW AND
SAVE**

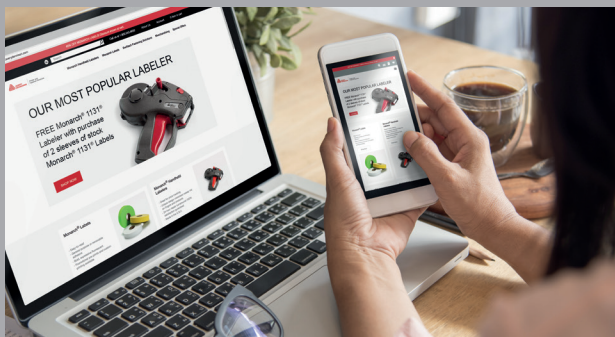

Sign up for our emails to receive:

- Valuable coupons
- Sales announcements

Visit: shopmonarch.averydennison.com/coupons

Shop online:
[averydennison.com/shopmonarch](https://www.averydennison.com/shopmonarch)

Call Monday-Friday 8:00am-7:00pm EST
Tel: 800-543-6650
Fax: 1-937-865-6605

Except for certain names on pages 27, 42-43, 48-49, all product designators (letters/numbers/names) and the serrated edge label design are trademarks of Avery Dennison Corporation. Various third party trademarks and trade names may be used herein and are the property of their respective owners.

The information contained herein is believed to be reliable but Avery Dennison makes no representations concerning the accuracy or correctness of the data. The products provided herein, like any other should be tested by the customer/user thoroughly under end user conditions to ensure the product meets the particular requirements. Individual results may vary.

For details on the information we collect, visit the Avery Dennison privacy policy at <https://www.averydennison.com/en/home/legal-and-privacy-notices.html>

Offers valid until 5/7/2020 or while supplies last and are subject to change or cancellation without notice.

All Monarch labelers are made in the USA with red touch points to help simplify the loading process. Most take 75% less time to load labels and 97% less time to change ink rollers than other labelers on the market. Independent results may vary.

© 2020 Avery Dennison Corporation. All rights reserved. Printed in USA